



AMPTEC RESEARCH MODEL 620UK-B OPERATION AND MAINTENANCE MANUAL



Intrinsically Safe ~ Failsafe

AMPTEC RESEARCH is an ISO 9001:2015 Certified Accredited Quality Management System Company

14101 Hwy 290 W. Bldg. 2000A
Austin, TX 78737
T: (512) 858-4045 E: info@amptec.com



TABLE OF CONTENTS

SECTION A: RECEIVING AND INITIAL INSPECTION

A-1 Introduction to AMPTEC 620UK-B Bonding Milliohmeter	p. 3
A-2 Unpacking and Inspection	p. 3
A-3 Setup and Preparation for Use	p. 4

SECTION B: 620UK-B SPECIFICATIONS

B-1 Specifications for AMPTEC 620UK-B Bonding Milliohmeter	p. 5
--	------

SECTION C: 620UK-B COMPATIBLE ACCESSORY ITEMS

C-1 Available Accessories and Test Leads	p. 6
--	------

SECTION D: OPERATION, FUNCTION, AND USE

D-1 General Use	p. 7
D-2 Front Panel	p. 7
D-2.1 Test Leads and Chassis Ground Connector	p. 7
D-2.2 Connections and 4 Wire Kelvin Information	p. 8
D-2.3 Main Power Switch	p. 8
D-2.4 Display and Backlight	p. 9
D-2.5 Resistance Range	p. 9
D-2.6 Low Battery Display Indicator	p. 9
D-2.7 Autolock Feature Information	p. 9
D-3 620UK-B Padded Carrying Case Photo and Information	p. 11
D-4 Detailed Use Description	p. 11

SECTION E: MAINTENANCE, REPAIR, AND CALIBRATION

E-1 General Maintenance, Repair, Calibration Information	p. 13
E-2 Returning the 620UK-B to AMPTEC for Maintenance, Repair, and Calibration	p. 13
E-3 Circuit Board Operation Overview	p. 13
E-4 Block Diagram and Circuit Description	p. 14
E-5 Principle of Operation	p. 14
E-6 Troubleshooting and Diagnostic Testing	p. 14
E-6.1 Current Source PCB Diagnostic Test Routine	p. 15
E-6.2 DVM PCB Diagnostic Test Routine	p. 15
E-7 620UK-B Calibration Adjustment Procedure	p. 15
E-7.1 Recommended Calibration Standards	p. 16
E-8 PCB Removal from Case	p. 16
E-9 Battery Compartment Design and Description	p. 17
E-9.1 Battery Replacement	p. 17

SECTION F: SAFETY APPROVALS AND CLASSIFICATIONS

F-1 UL-913 Intrinsically Safe Certification	p. 18
F-2 MIL. STD. 810 MTD. 511 Certification	p. 18

SECTION A: RECEIVING AND INITIAL INSPECTION

A-1 Introduction to AMPTEC 620UK-B Bonding Milliohmmeter

Originally designed at the request of Lockheed Martin's engineering team, the AMPTEC 620UK-B Bonding Milliohmmeter has become the standard in its industry, being used in maintenance wings across the globe. The 620UK-B meter provides extremely safe and reliable resistance testing on explosive or volatile devices at all times. Our various safety board approvals (found in section F on page 18) demonstrate our dedication to making quality products that are safe to use in a variety of atmospheres and environments.

The AMPTEC 620UK-B Bonding Milliohmmeter is UL-913 approved as an intrinsically safe apparatus for use in Class 1, Division 1, Groups A, B, C, and D locations for ambient temperatures from -20° C to 50° C (T3 zones). The AMPTEC 620UK-B meter is also MIL. STD. 810 MTD. 511 approved for use in explosive and volatile atmospheres.

Devices/processes that the 620UK-B meter can be used for include, but are not limited to:

- Electrical chassis ground connections and continuity determination(s) on electrical subsystems used in general purpose aircraft, helicopters, fighter jets, UAVs, drones, missiles, etc.
- Continuity determinations on fuses, electrical cable connections, heavy duty metal to metal connections
- Bonding measurements for metal to metal connections

Featuring an all metal case with a separate F.O.D. resistant battery compartment, the AMPTEC 620UK-B meter has been specifically designed to keep ease of use and reliability in mind. When it comes to safety, the 620UK-B meter has failsafe output circuitry pioneered by AMPTEC to ensure that test current levels do not exceed the specified failsafe current, even in worst-case component failure situations.

We're extremely proud of the engineering and quality that goes into each and every one of our products we've created over the past 20 years. We hope you enjoy working with our 620UK-B meter and encourage you to contact us if you have any questions or comments. Thank you for your business!

A-2 Unpacking and Inspection

Should the box you receive your product in be damaged upon its arrival, notify AMPTEC and the shipping carrier immediately. If your 620UK-B meter appears damaged, the carrier's agent should authorize repairs before the unit is returned to our facility.

If the unit fails to operate or meet performance specifications (listed in section B on page 5) notify the carrier's agent and AMPTEC immediately. Retain the shipping container for the carrier's inspection.

Do not, under any circumstance, return equipment to any of AMPTEC's facilities or sales offices without first obtaining an RMA number (see section E-2 on page 13) from an AMPTEC staff member. We must obtain your full contact information in order to properly coordinate the repair and return of the AMPTEC meter.

A-3 Setup for Preparation and Use

The following quick-step guide can be taken to power up and use the AMPTEC 620UK-B meter:

- 1) The meter may be set up to operate as soon as the power is turned on, which can be accomplished by pressing and holding down the power switch for 2 seconds.
- 2) Connect the unit's chassis ground panel jack on the front panel to a local earth or ground connection.
- 3) Check the product's display for a low battery indication. If the product has a low battery, the display will say "LO BAT". To see instructions on battery replacement, see section E-9.1 on page 17.
- 4) Perform a visual test lead integrity check. It is recommended that the user perform a basic visual inspection of their test lead set to confirm there is no damage to any portion of the set.
- 5) Perform a multimeter continuity test of your test lead set. To do so, ensure all four wires are isolated from each other, and then connect each pin to its corresponding opposite pin. Many multimeters will simply beep to indicate that the leads you are testing are operational.

For a more detailed instructional information on how to use the 620UK-B meter, see section D-4 on page 11.

The 620UK-B meter may be used in any area where the environment does not exceed the specifications listed in section B on page 5. When possible, avoid exposing the meter to extremes of temperature, which will affect accuracy and shorten battery life. One should become familiar with the basic test lead usage and the autolock feature described in detail in this manual in Section D-2.4 on page 9 in order to properly use the unit.

SECTION B: 620UK-B SPECIFICATIONS

B-1 Specifications for AMPTEC 620UK-B Bonding Milliohmmeter

Resistance Range/Resolution:	RANGE	200 mΩ	2 Ω
	NOMINAL CURRENT	100 mA	100 mA
	RESOLUTION	.01 mΩ	.1 mΩ
	RANGE	200 mΩ	2 Ω

Accuracy: Below is valid for 1 year from -20° C to 50° C when stabilized at ambient temperature after a 3 minute warmup:

200 mΩ range: ± 0.10 mΩ or 10 counts

2 Ω range: ± 1 mΩ or 10 counts

Calibration: It is recommended that the product is calibrated in 1 year intervals. See section E-7 on page 15 for calibration instructions.

Dimensions: 7.69" W x 7.56" D x 3" H.

Hazardous Use Locations: Unit is independently UL-913 approved for use in Class 1, Division 1, Groups A, B, C, and D locations from -20° C to 50° C, as well as MIL. STD. 810 MTD. 511 approved for use in explosive and volatile fuel atmospheres.

Instrument Display: Display is 20,000 counts, 4 ½ digit liquid crystal display with a back light that indicates autolock. See section D-2.7 on page 9 for additional information about the autolock feature.

Low Battery Indication: Display shows "LO BAT".

Measurement Update Rate: Appox. 3 readings per second.

Open Circuit Current Source Compliance Voltage: ~5.0 VDC

Over-Range Indication: Display shows "1 - - -" and ">>>OR".

Power: Disposable AA alkaline batteries inside separate chemical and F.O.D. resistant metal battery box. 4 batteries power the unit, and are 1.5 VDC AA alkaline type Duracell MN1500. Do not mix battery brands and always replace all batteries at same time. See section E-9.1 on page 17 for instructions on battery changing.

Temperature Range: Unit can operate from -20° C to 40° C at rated accuracy. Unit can be stored from -20° C to 70° C.

SECTION C: 620UK-B COMPATIBLE ACCESSORY ITEMS

C-1 Available Accessories and Test Leads*

620UK-B Product Packages:

620UK-B NSN PKG: Includes meter, case (630-100), and probes (630-406S)



620UK-B Meter Accessories:

630-100: Padded F.O.D. resistant case



620UK-B Test Leads and Probes:



600-PG: 5' dual pistol grip probes

600-PROC: 5' compass probe and dual point clamp

600-PROX2: 4' Dual compass style probes

600-401C: 5' twin single point current clamps & two voltage probes

630-300: 4' Kelvin clip lead set

630-304: 4' 4-Wire banana jack test lead set

630-304G: 4' 4-Wire banana jack test lead set with ground

630-305: 4' Twin single banana jack lead set

630-401: 4' Single point handheld Kelvin probes

630-405K: 10' heavy duty spiked Kelvin probes

630-405S: 10' heavy duty spear Kelvin probes

630-406S: 5' heavy duty spear Kelvin probes

630-407P: 10' and 5' heavy duty spiked probes w/ spare tips

630-408J: 10' heavy duty Kelvin clamp test lead set

KIT8268: Set of 600-401C probes, 600-PROC probes, 600-PG probes, 600-PROX2 probes, and 630-401 probes in pelican case



AMPTEC is also well-versed in making custom accessories and lead/probe sets. Contact us for any custom requirement you may have to see if AMPTEC can provide you with a solution.

*For pricing information on our packages, accessories, and lead/probe sets, please contact AMPTEC. Please note that the above list may change over time, as we update our price list on an annual basis. Contact AMPTEC to receive the most current list of 620UK-B compatible accessory items.

SECTION D: OPERATION, FUNCTION, AND USE

D-1 General Use

The AMPTEC 620UK-B is a milliohmmeter designed to safely measure low level DC resistance from 0.01 to 1999.9 mΩ. The 620UK-B meter uses internal solid state voltage reference(s) that permit the product to be used immediately after the unit has been turned on (temperature range limits permitting). If you flip the carrying case lid completely open, and connect the carrying case strap to the unit's front buckle, the unit can be carried hands free.

To use the 620UK-B meter to make a resistance measurement, first connect the desired measurement leads to the Trident connector on the front panel of the meter. Place the measurement leads across the unknown resistance value that needs to be measured. At this point, the 620UK-B meter should start updating the LCD screen once an electrical connection has been made. After approximately 3 seconds, the meter will produce a beeping sound, and the backlight will turn on to illuminate the LCD screen. If the measurement leads are removed from the component that was being measured, the meter will hold the resistance reading on the screen. The 620UK-B meter will resume measuring resistance once the measurement leads sense a new applied resistance value, or by pressing the “Auto Measure Reset” button.

If you have any other general use questions, please contact AMPTEC.

D-2 Front Panel

The below sub-sections, D-2.1 through D-2.7, provide information on the features, design, and uses of the 620UK-B meter's front panel. The below photo also shows the details of the 620UK-B's front panel.

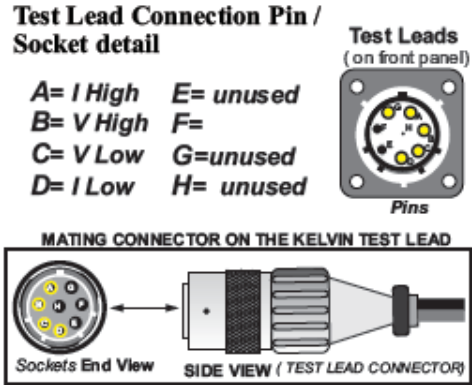


D-2.1 Test Leads and Chassis Ground Connections

The AMPTEC 620UK-B meter test lead connection uses a 4 terminal-in connector on its front panel, as seen in the diagram on the next page.

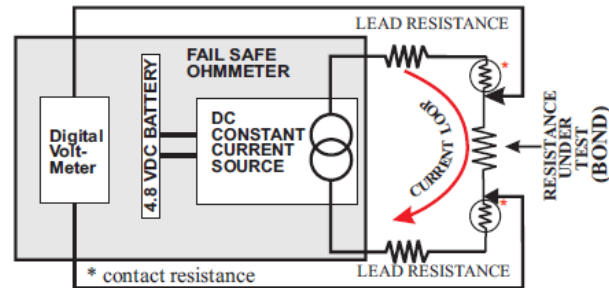
The unit's front panel chassis ground panel jack (which also accepts an external banana jack) is wired to its all metal case, metal front panel, rear panel, battery compartment,

and “pin G” of the test lead connector (see diagram on right). The unit’s chassis ground can also be plugged into an earth ground connection (for example, at the test site to preclude any static voltages from building up, if desired). To prevent damaging the gold pins and sockets, only use AMPTEC test leads that are model 620UK-B compatible. When using AMPTEC test leads or probes, the notched connector end plugs directly into the single access notched main connector. Turn the connector collar clockwise until you feel the click of the mating connector.



D-2.2 Alternate Connections and 4-Wire Kelvin Information

The AMPTEC 620UK-B meter is compatible with most AMPTEC 630 series accessories. 620UK-B compatible test lead/probes use a Trident connector on the front panel as the main connection for lead/probe sets. The diagram on the right also provides insight on how the 620UK-B operates. The Trident connection



provides the same pin socket arrangement, 4-Wire current high/low, and voltage sense high/low routed to the end of the leads, and the 4-Wire Kelvin wires then terminate in a variety of configurations depending upon the accessory. The 620UK-B keyed access connector also makes it virtually impossible during normal operation to incorrectly connect lead/probe sets.

The 620UK-B meter measures DC resistance with a 4-Wire Kelvin, or 4 terminal ohms, technique. Fundamentally, the 4-Wire Kelvin resistance method avoids measurement errors induced from the resistance of the test lead/probes and the contact resistance of the lead/probes to the device under test. Two of the wires, current high and current low, pass through the bond resistance under test in a current loop as part of a constant current source of 100 mA. It doesn’t matter if the current loop is longer or if there is some contact resistance with the connection under test, because the constant current source’s compliance voltage works to maintain 100 mA flowing in the loop. The other 2 wires, voltage high and voltage low, sense the voltage drop across the resistance under test. The voltage measurement is high impedance. Meaning, virtually no current is drawn in either voltage sense lead wire.

In conclusion, with 4-Wire Kelvin measurements, long distance test leads do not create a measurement error as long as you have enough compliance voltage remaining in the constant current loop. If test resistance is too high for the range, the meter will flash “1 - - - -” and “>>>OR” to indicate the meter is over range.

D-2.3 Main Power Switch

To turn the unit on, the unit's main power switch must be pressed for 2 seconds. This momentary hold down routine was designed to prevent accidental power on while the product is in its carrying case. When the power switch is first pressed and held, the instrument's LCD display should light up, as well as a small LED on the front panel, indicating that the unit is now on. If the switch is pressed again, the unit will turn off. The main power switch is covered with a silicon rubber boot to provide added water/dust resistance. Under the rubber boot, there is a rubber o-ring for added weather resistance.

The 620UK-B meter is set to automatically turn itself off after 5 minutes of no use in order to preserve battery life. Contact AMPTEC if you would like to have this feature deactivated.

D-2.4 Display and Backlight

The 620UK-B's display backlight is yellow in color, and will light up when the unit is powered on. As the 620UK-B's display is LCD (liquid crystal display) and high quality, the display itself should have a life lasting many years. Should the display become damaged or stop operating properly, it can be replaced at an AMPTEC facility.

The unit's autolock feature turns the meter's backlight on and will freeze the reading unless the "AUTO MEASURE RESET" button on the front panel is pressed or the meter senses probe continuity is still established. Additionally, the display backlight is off while the measurement portion of its cycle is active.

D-2.5 Resistance Range

The 620UK-B can make measurements from 0.00 to 1999.9 m Ω . The meter starts in Auto Range, but pressing the "AUTO MEASURE RESET" button when the meter's backlight is not on allows the user to cycle through the Auto, 200 m Ω , and 2 Ω ranges.

If a measurement is made that results in the unit being over-range, the display will indicate this with ">>> OR" and "1 - - - -".



D-2.6 Low Battery Indicator

If the unit is running low on battery, the display will indicate this by showing "LO BAT" in the top left corner. See section E-9.1 on page 17 for information on how to change the instrument's batteries.

D-2.7 Autolock Feature Information

The 620UK-B meter has a built-in autolock feature, in which the unit senses continuity was established, and automatically samples readings and locks on the most accurate resistance measurement.

This autolock feature within the meter works by taking 16 resistance measurements in the positive polarity and averaging them. Another 16 resistance measurements are then taken in the negative polarity and averaged. The two averaged values from the positive and negative polarities are then averaged together to produce the final autolocked measurement, which is the reading displayed while the backlight is on.

To assist the user, the meter produces an audible beeping indicator along with the lit backlight once an autolock measurement has been found. This beeping allows the user to focus on the placement of the measurement leads, instead of on the meter's display.

The autolock feature also enables the measurement to reset automatically if continuity is sensed or front panel button "AUTO MEASURE RESET" is pressed. The display's backlight will turn off while the measurement portion of its cycle is active, and light up when the instrument has locked on a measurement.

D-3 Carrying Case Photo and Information

The 620UK-B can be carried and operated easily hands free. Using the straps on the case, you can hang the meter over your head and neck, leaving your hands free to use a lead/probe set to make a measurement. The below itemized list references figure 2 (note the photo is of our 620LK meter, which is identical in function to the 620UK-B meter).

Item A: ITT Cannon/Trident Kelvin test lead Connector with waterproof dust cap.

Item B: Chassis ground connector. Chassis is connected completely to case. Case is all aluminum, including front and rear panels.

Item C: 4 ½ Digit LCD Display with “LO BAT” and “<<<OR” shown as an example.

Item D: AUTO MEASURE RESET BUTTON. Press and hold to reset a measurement that has been locked.

Item E: Power On/Off Switch with LED. Press and hold for 2 seconds to power the unit on. The display backlight and a small LED on the front panel will indicate the power is on.

D-4 Detailed Use Description

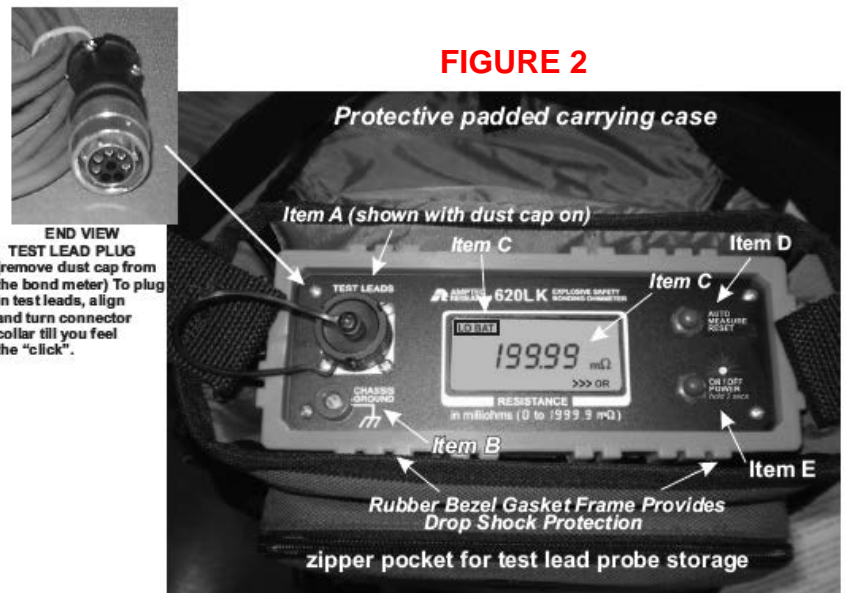
The below provides a detailed description on the best way to use the 620UK-B meter for bond measurements. You may also view the diagram on the following page for a visual example. Please note that while the diagram is of the 620LK meter, the 620UK-B meter is identical in function and design and as such, the diagram is accurate.

Starting out, the Kelvin probes should not be touching a conductor - the meter is open circuit and the display indicates "1- - -". Find a clean area on both the part you need to

FIGURE 1

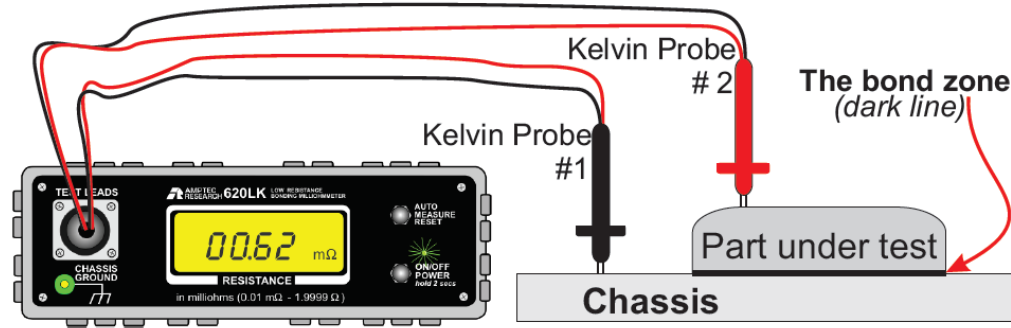


FIGURE 2



**END VIEW
TEST LEAD PLUG**
(remove dust cap from the bond meter) To plug in test leads, align and turn connector collar till you feel the "click".

test (no paint or coating), and the metal chassis of your test item. Pointed probes work best on aluminum parts as this type of material often has a thin coating (aluminum oxide) that is a non-conductor. Press and hold each probe with a steady hand, and note it is only necessary to push the probe tip springs in about half way. Do not move the probes for 3 to 5 seconds. The meter has 2 resistance ranges (a 199.99 mΩ range and a 1.9999 Ω range) and needs a little settling time to automatically determine which range is best before displaying the calculated bond value.



Bond measurements are typically a "PASS" or "FAIL" inspection to determine if the bond is better than (or lower than) a given resistance level (ie 20 mΩ , 5 mΩ , 2.5 mΩ , 1.0 mΩ)

When the display backlight comes on, the meter has made a bond measurement. The probes may be removed while the unit's backlight is on, as the unit's autolock feature freezes the reading. The backlit frozen measurement will stay frozen until you either press the "AUTO MEASURE RESET" button or press the test probes against a conductor (meaning continuity is sensed). When ready to make another measurement, simply place the probes back on the test items, and the meter will automatically make another measurement. See section D-2.7 on page 9 for more information regarding the autolock feature.

The user may use the unit's carrying case with padded straps to securely hold the bond meter around their neck, while their hands hold the Kelvin probes and make bond measurements. Repetitive measurements assure a good bond measurement; it may be necessary to hold the probes down for 2 consecutive displayed measurement cycles to avoid any timing issue of probe placement in the unit's measurement cycle, and assuring the first initial settling in on the proper range. Bond measurement is almost always a pass/fail test to determine if the bond is better than a given resistance level.

SECTION E: MAINTENANCE, REPAIR, AND CALIBRATION

E-1 General Maintenance, Repair, and Calibration Information

The AMPTEC 620UK-B meter was designed with the intent of using high quality, strong, and reliable components both internally and externally. As a result, the unit is extremely reliable and rarely requires repair. Should the unit require maintenance or repair that cannot be performed by the end user, we recommend sending the product to AMPTEC RESEARCH's facility to perform this service. Malfunctions can sometimes be the result of bad test lead/connection wiring, wrong connections, misinterpretation of specifications, low battery levels, or a misunderstanding of how to use the product.

The below sections will provide information on sending your unit to AMPTEC for repair, as well as how the user can perform some maintenance, troubleshooting, and calibration techniques on their own.

E-2 Returning the 620UK-B to AMPTEC for Maintenance, Repair, and Calibration

AMPTEC RESEARCH has been proudly providing product support for all of our equipment for the past 20 years. Part of this support is offering maintenance, repair, and calibrations for our instrumentation. Our staff is highly trained across our product lines and is capable of fixing nearly any issue your instrument may have. AMPTEC maintains one sole facility for both the manufacturing and repair of its products:

**AMPTEC RESEARCH CORP.
14101 Hwy 290. W.
Bldg. 2000A
Austin, TX, USA 78737**

Should you have a product that you would like to be sent in for maintenance, repair, or calibration, it can be sent to the address above. **Before sending in a product to our facility, you must contact a member of our staff and receive an RMA #.** We can be reached via email at info@amptec.com or phone at 512-858-4045. The purpose process of this is so that we can obtain your full contact information and properly coordinate the return of the AMPTEC meter.

Once we have received your meter, we will diagnose the issue for free and provide you with pricing information. If diagnosing the problem requires one of our technicians to open the product in order to reach the internal circuitry, a calibration fee will be required for us to send the product back to you. This is because we have a plant-wide policy that all instrumentation must be calibrated before leaving our facility – it would be unethical to allow out of ordnance products to be sent to an end user.

E-3 Circuit Board Operation Overview

There is one internal printed circuit board (PCB) that performs the digital ohmmeter resistance measurement. The AMPTEC 620UK-B meter uses a constant current source circuit and DVM circuitry all on one PCB. When the constant current source is combined with the digital voltmeter circuit, the result is a stable DC resistance measurement.

The DVM PCB's electronics use a high input impedance voltage sense circuit. This circuit draws very little current, while measuring the DC voltage drop across the resistance under test. The AMPTEC 620UK-B main PCB slides in easily, by following grooves on the inside of the aluminum case.

Schematics for the 620UK-B's PCB are protected and strictly confidential, regardless of the circumstance.

E-4 Block Diagram and Circuit Description

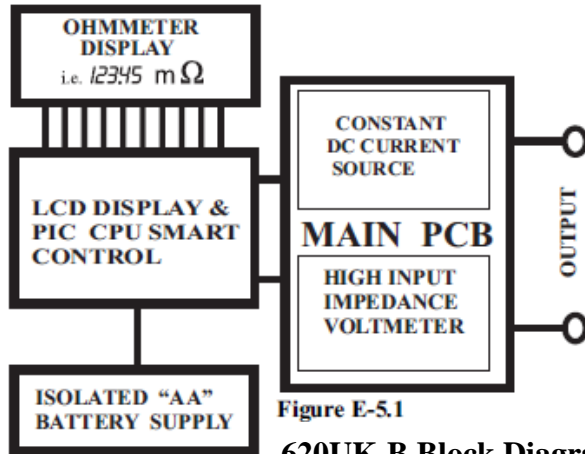


Figure E-5.1

620UK-B Block Diagram

E-5 Principle of Operation

Using Ohm's Law ($V/I = R$), the AMPTEC 620UK-B Bond Meter first outputs constant DC current through a given test resistance, then measures the voltage drop across it while scaling its display as resistance. The 1.9999 Ω range outputs a constant 100 mA DC level of test current. On a 1 Ω resistor, the 620UK-B 100mA output should get a 100mV drop (0.10V/0.10A). For DVM scaling on the 2 Ω range, voltage drop is amplified using a x10 (for range scaling), hence a 10 mV drop becomes 100mV. This DVM input is displayed as 100.00 m Ω on a 0.100 Ω std. During the cycle, the meter changes polarity, samples again, and displays the average reading of both polarities.

E-6 PCB Troubleshooting and Diagnostic Testing

If the malfunction is a faulty part, the repair of the 620UK-B meter can be attained by replacing the proper internal PCB. There are no serviceable components (much of the components are surface mount) on the 620UK-B PCBs, so it is often a case of entire PCB replacement. See section E-2 on page 13 for more information about sending your product in for repair.

The following sub-sections will facilitate the diagnosis as to whether the AMPTEC 620UK-B current source circuitry or digital voltmeter circuitry needs repair or replacement. These steps should only be performed by authorized personnel who are trained to do so.

E-6.1 Current Source PCB Diagnostic Test Routine

The following steps can help determine if the current source circuitry is faulty:

- 1) Put output leads across a 0.100 Ω resistance standard (0.005% or better).
- 2) Measure the voltage drop with a DC Voltmeter. It should be 0.0100V.

If the above test proves untrue, then the current source circuitry is possibly faulty, and may need replacing. See section E-2 on page 13 for more information about sending your product in for repair.

E-6.2 Digital Voltmeter (DVM) PCB Test Routine

The following steps can help determine if the DVM circuitry is faulty:

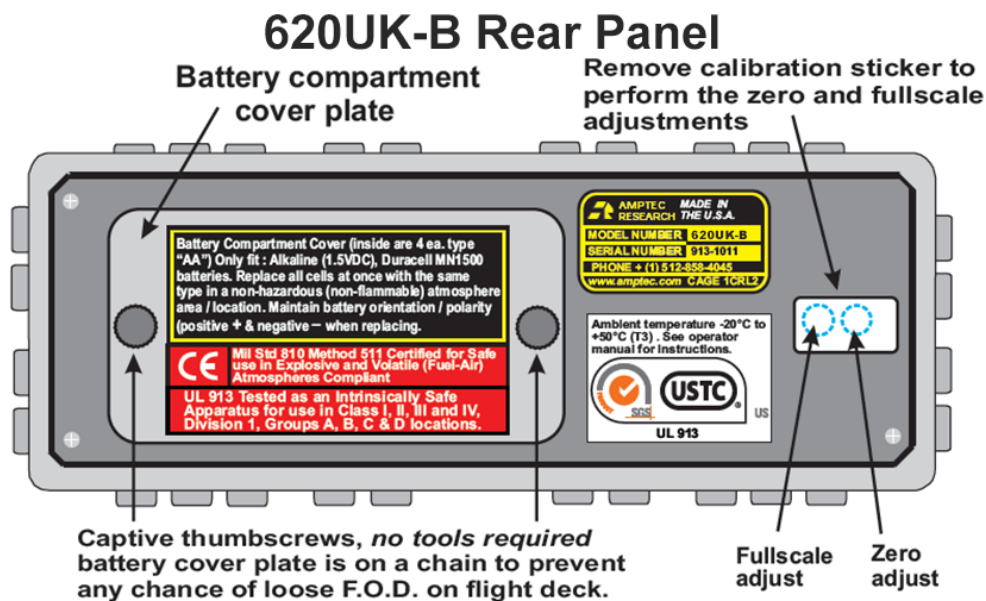
- 1) Short the output leads.
- 2) Check for a reading of 0.000.
- 3) Put the output leads across a 0.100 Ω resistance standard.
- 4) The display should read 100.00 m Ω (\pm 10 counts depending on the resistor's accuracy).

If the above test proves untrue, then the DVM circuitry is possibly faulty, and may need replacing. See section E-2 on page 13 for more information about sending your product in for repair.

E-7 620UK-B Calibration Procedure

The 620UK-B's rear panel calibration sticker must be removed to access the two adjustment potentiometers located on the DVM PCB. **Please note that if the tamper-proof calibration sticker is removed, this voids the product's calibration and warranty.**

All the meter's calibration adjustments (via trimpots) are accessed through two holes located in the upper right area of the rear panel, under the tamper-proof calibration sticker. The two holes (see diagram below) are for zero and full-scale adjustments. A set of two hole plugs normally cover the zero and full-scale adjustment holes.



Zero Adjustment: With a precision $0.001\ \Omega$ ($1.0\ \text{m}\Omega$) resistance standard that's 0.005% or better, connect 4-Wire Kelvin test jacks (630-304) to the AMPTEC 620UK-B meter. Through the top far right rear panel hole, adjust the trim-pot (see above diagram labeled zero) to make the meter read the exact value of the $.0\ \text{m}\Omega$ laboratory standard resistor (i.e. $\sim 1.00\ \text{m}\Omega$ value will be displayed). Because of the autolock feature, you will have to wait 5 to 10 seconds between adjustments and readings for settling and an updated display of the measurement. The meter will continue to sample and hold, and then resample as long as it senses any continuity.

Full-scale Adjustment: Next, connect the meter via the 630-304 test leads across a precision $100\ \text{m}\Omega$ resistance standard which is a 0.005% or better accuracy resistance standard. Adjust the full-scale pot, using the hole located to the top left of the rear panel zero pot access hole (see above diagram labeled fullscale), until the display is the actual value of the $100\ \text{m}\Omega$ resistance standard in milliohms (i.e. $99.97\ \text{m}\Omega$ if the standard is actually $0.09997\ \Omega$ s). Because of the autolock feature, you will have to wait 5 to 10 seconds between readings for settling and an updated display of the measurement. The meter will continue to sample and hold, and then resample as long as it senses any continuity.

Finally, connect the meter via the 630-304 test leads across a precision $1.0\ \Omega$ resistance standard which is a 0.005% or better accuracy resistance standard. Allow a few seconds for settling time. Keep in mind the meter autoranges up to the $2.0\ \Omega$ range when measuring a value above $200\ \text{m}\Omega$. Verify the meter is within 5 counts ($\pm .005\ \Omega$) on a $1.0\ \Omega$ standard.

This concludes the adjustment procedure for the AMPTEC 620UK-B meter.

E-7.1 Recommended Calibration Standards

We recommend using our 630-304 4-Wire banana jack test lead set to calibrate the 620UK-B meter. If you are interested in purchasing a set of these leads, please contact AMPTEC.

If you need to purchase resistance standards, we recommend using a reputable manufacturer and insuring that all standards are N.I.S.T. traceable. AMPTEC currently uses [Ohm-Labs](#) for many of its standards.

AMPTEC has a full-scale calibration laboratory within its manufacturing facility, and has the full capability to calibrate your product(s) for you. If you are interested in using our calibration services, please see section E-2 on page 13.

E-8 PCB Removal

Removing the PCB from any of our products is strongly discouraged. If a user is going to perform the task, they need be authorized and trained. AMPTEC provides a free PCB replacement for products under warranty, and a small fee for non-warranty products.

Removing the PCB from the 620UK-B meter will void the product's warranty and calibration. The following procedure can be performed to remove the PCB from the 620UK-B meter:

- 1) Use a Philips screwdriver to remove the 620UK-B's 4 front panel screws located in the corners.
- 2) Pull the front panel forward carefully and slowly.
- 3) Slide out the display PCB. Use caution with doing this, as there are 4 wires (battery supply positive and negative, and 2 DVM sense wires) and a single ribbon cable (going to the display PCB) that connect the front panel electronics to DVM PCB circuitry mounted inside the case.
- 4) Slide out main PCB.
- 5) Disconnect all wires and cables that go to the faulty PCB.
- 6) Reinstall all wires and cables onto the new PCB.
- 7) Follow the calibration procedure in section E-7 on page 15.
- 8) Slide the main PCB back in, and replace the front panel and screws.

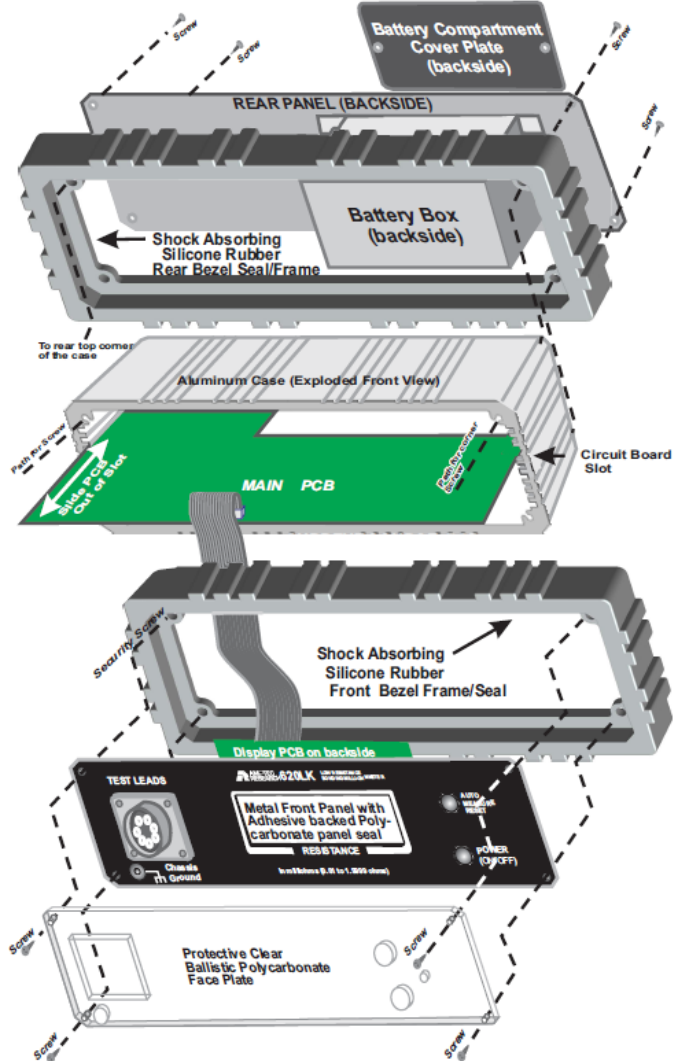
E-9 Battery Compartment Design and Description

The metal battery compartment is powder coated to make it chemically resistant to battery leakage, and backed with a water tight rubber based compression gasket liner. The battery supply wiring insulation is made of extra thick (> 5mm) Teflon to provide excellent resistance to abrasion. Since the batteries are in a separate compartment where the operator has no access to the unit's internal electronics, any user may replace the batteries as needed and this activity does not interfere with the unit's warranty or calibration.

E-9.1 Battery Replacement

To replace the batteries, you must remove the two retaining screws securing the battery compartment cover plate on the rear panel. In order to be UL-913 compliant, the batteries must be AA alkaline (1.5 VDC) type Duracell MN1500. Do not mix battery batches or brands for any reason. Make sure to replace all four batteries at the same time, and re-secure new batteries with a plastic cable tie or similar fastener.

Note that the below diagram is of the 620LK meter. However, the 620UK-B meter is identical in function and design, and as such the diagram is accurate.



SECTION F: SAFETY APPROVALS AND CLASSIFICATIONS

F-1 UL-913 Intrinsically Safe Certification

The AMPTEC 620UK-B meter is independently UL-913 approved as an intrinsically safe apparatus for use in Class 1, 2, 3, and 4, Division 1, Groups A, B, C, and D locations from temperatures -20° C to 50° C. This certification was gained in 2013, and is maintained with quarterly inspections by an independent party.

AMPTEC also follows UL-913's quality standards plant-wide, including the adoption of a quality manual, policies for non-conforming parts, policies for personnel, and many more.

If you are interested in obtaining a copy of AMPTEC's UL-913 certification, please contact our sales dept.

F-2 MIL. STD. 810 MTD. 511 Certification

The AMPTEC 620UK-B meter is MIL. STD. 810 MTD. 511 approved for use in explosive and volatile fuel environments.

If you are interested in obtaining a copy of AMPTEC's MIL. STD. 810 MTD. 511 certification, please contact AMPTEC.

