

Digital Oscilloscope & Multimeter

GDS-122

USER MANUAL

GW INSTEK PART NO.



ISO-9001 CERTIFIED MANUFACTURER

GW INSTEK

This manual contains proprietary information, which is protected by copyrights. All rights are reserved. No part of this manual may be photocopied, reproduced or translated to another language without prior written consent of Good Will company.

The information in this manual was correct at the time of printing. However, Good Will continues to improve products and reserves the rights to change specification, equipment, and maintenance procedures at any time without notice.

Windows is a registered trademark of Microsoft Corporation in the United States and other countries.

Good Will Instrument Co., Ltd.
No. 7-1, Jhongsing Rd., Tucheng City, Taipei County 236, Taiwan.

TABLE OF CONTENTS

Safety Instructions	6
Getting Started	9
Package Contents	10
Main Features.....	11
Front Panel and Keys Overview	12
Manual Overview	14
Using the Oscilloscope	15
Basic Operations.....	16
1. Powering up the GDS-122.....	16
2. Connecting an input signal	17
3. Using the Autoset function.....	18
4. Introducing the display contents	18
5. Adjusting waveform scales.....	19
6. Adjusting waveform positions.....	20
Configurations	21
Configuring channel (vertical) settings	21
Configuring horizontal settings.....	24
Configuring trigger settings: general settings	26
Configuring trigger settings: edge triggering	29
Configuring trigger settings: video triggering	32
Selecting the acquisition mode.....	34
Selecting the language	35
Configuring display settings	36
Viewing the system status.....	37
Measurements	39
Running waveform maths.....	39
Running automatic measurements	41
Running time cursor measurements.....	42
Running voltage cursor measurements	43
Advanced Viewings	45

Zooming waveforms horizontally	45
Viewing waveforms in X-Y format	47
Viewing signal peaks	48
Viewing noisy signals.....	49
Viewing variations in a signal.....	50
Calibration	51
Running the self calibration	51
Running the probe calibration.....	52
Saving/Recalling	53
Recalling the default settings.....	53
Saving waveforms	54
Recalling waveforms	55
Menu Tree / Operation Shortcuts	56
Trigger	56
CH1/CH2 Setup	56
Measurement Setup 1/2.....	57
Wave Math	57
Cursor Measurement.....	57
Acquisition Mode	58
Time Mode.....	58
Function	58
Display	59
Wave Save.....	59
System Status	59
OSC OPTION key	60
Using the Software	61
Installing the software	62
Modifying/Reinstalling/Uninstalling the software.....	64
Activating the software and connecting the GDS-122 ..	65
Configuring the screen	68
Viewing the waveforms	71
Using the cursor measurements.....	75
Saving waveforms	77
Recalling waveforms	79
Printing out waveforms	80
Accessing the Help	82
Using the Multimeter	83

Activating the Multimeter 84

Measuring Voltage 85

Measuring Current 87

Measuring Impedance 89

Measuring Diode 91

Measuring Continuity 92

Measuring Capacitance 93

Faq..... 95

Specifications..... 97

 Oscilloscope specifications 97

 Multimeter specifications 98

 General specifications 99

Declaration of Conformity 100







Index..... 101

SAFETY INSTRUCTIONS

This chapter contains important safety instructions that you should follow when operating the instrument and when keeping it in storage. Read the following before any operation to ensure your safety and to keep the instrument in best condition.

Safety Symbols

These symbols may appear in this manual or on the instrument.

	WARNING	Warning: Identifies conditions or practices that could result in injury or loss of life.
	CAUTION	Caution: Identifies conditions or practices that could result in damage to the instrument or to other properties.
		DANGER: High Voltage
		Attention: Refer to the Manual
		Protective Conductor Terminal
		Earth (ground) Terminal

Safety Guidelines

- General Guidelines
- Do not place heavy objects on the instrument.
 - Avoid severe impacts or rough handlings that may damage the instrument.
-  **CAUTION**
- Avoid discharges of static electricity onto or near the instrument.
 - Do not insert bare wires or metal objects into the terminals.
 - Do not apply input voltage more than 42V peak (30Vrms) to the instrument.

- Do not perform measurements at a power generating source or building installation site (see note below).
- The instrument should only be disassembled by a qualified technician.

(Measurement categories) EN 61010-1:2001 specifies the measurement categories and their requirements as follows. This instrument falls under category I. Measurement category IV is for measurement performed at the source of low-voltage installation. Measurement category III is for measurement performed in the building installation. Measurement category II is for measurement performed on the circuits directly connected to the low voltage installation. Measurement category I is for measurements performed on circuits not directly connected to Mains.

Power Supply



WARNING

- AC Input voltage: 100 to 240V, 50/60Hz
- The power supply voltage should not fluctuate more than 10%.
- Always use the AC adaptor included in the package.
- Always connect the AC adaptor to the mains line first, then to the instrument.

Cleaning the instrument

- Disconnect the power cord before cleaning the instrument.
- Use a soft cloth dampened in a solution of mild detergent and water. Do not spray liquid into the instrument.
- Do not use chemicals or cleaners containing harsh products such as benzene, toluene, xylene, and acetone.

Operation Environment

- Location: Indoor, no direct sunlight, dust free, most non-conductive pollution (see note below)
- Relative Humidity: < 75%
- Altitude: < 2000m
- Temperature: 0°C to 40°C

(Pollution Degree) EN 61010-1:2001 specifies the pollution degrees and their requirements as follows. This instrument falls under degree 2. Pollution refers to "addition of foreign matter, solid, liquid, or gaseous (ionized gases), that may produce a reduction of dielectric strength or surface resistivity".

Pollution degree 1: No pollution or only dry, non-conductive pollution occurs. The pollution has no influence.

Pollution degree 2: Normally only non-conductive pollution occurs.

Occasionally, however, a temporary conductivity caused by condensation must be expected.

Pollution degree 3: Conductive pollution occurs, or dry, non-conductive pollution occurs which becomes conductive due to condensation which is expected. In such conditions, equipment is normally protected against exposure to direct sunlight, precipitation, and full wind pressure, but neither temperature nor humidity is controlled.

Storage environment

- Location: Indoor
- Relative Humidity: < 75%
- Temperature: -10°C to 70°C

Power cord for the United Kingdom

When using the instrument in the United Kingdom, make sure the power cord meets the following safety instructions.

NOTE: This lead/appliance must only be wired by competent persons

⚠WARNING: THIS APPLIANCE MUST BE EARTHED

IMPORTANT: The wires in this lead are coloured in accordance with the following code:

- Green/ Yellow: Earth
- Blue: Neutral
- Brown: Live (Phase)



As the colours of the wires in main leads may not correspond with the colours marking identified in your plug/appliance, proceed as follows:

The wire which is coloured Green & Yellow must be connected to the Earth terminal marked with the letter E or by the earth symbol ⊕ or coloured Green or Green & Yellow.

The wire which is coloured Blue must be connected to the terminal which is marked with the letter N or coloured Blue or Black.

The wire which is coloured Brown must be connected to the terminal marked with the letter L or P or coloured Brown or Red.

If in doubt, consult the instructions provided with the equipment or contact the supplier.

This cable/appliance should be protected by a suitably rated and approved HBC mains fuse: refer to the rating information on the equipment and/or user instructions for details. As a guide, cable of 0.75mm² should be protected by a 3A or 5A fuse. Larger conductors would normally require 13A types, depending on the connection method used.

Any moulded mains connector that requires removal /replacement must be destroyed by removal of any fuse & fuse carrier and disposed of immediately, as a plug with bared wires is hazardous if a engaged in live socket. Any re-wiring must be carried out in accordance with the information detailed on this label.









GETTING STARTED

This chapter gives you an overview of what the GDS-122 is about, what items are included in the package, and how the user manual is organized. After opening the GDS-122 package, check the contents referring to the *Package Contents* section, then learn the features and interface reading the *Main Features* and *Front Panel and Keys Overview* section. The Manual Overview section gives you an overall picture of what each chapter is about, helping you directly jump to the relevant location.

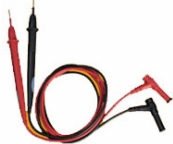

Package Contents	10
Main Features	11
Front Panel and Keys Overview	12
Manual Overview	14

Package Contents

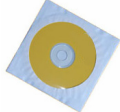
<p>Carrying case</p> 	<p>GDS-122</p> 
<p>AC-DC adaptor</p> 	<p>Oscilloscope probe x 2</p> 
<p>Probe adjustment tool</p> 	<p>Multimeter test lead x 2</p> 
<p>Extension module for large current measurement</p> 	<p>Extension module for small capacitance measurement</p> 
<p>Serial data communication cable</p> 	<p>User Manual (this document)</p>
<p>CD-ROM (PC software)</p> 	

Main Features

Oscilloscope	<ul style="list-style-type: none"> • Dual channel • 20MHz bandwidth • 100MS/s real-time sampling rate • ≤ 17.5ns rising time • 5ns to 5s/div horizontal scale • 5mV to 5V/div vertical scale • 6k memory points per channel • Isolated inputs between oscilloscope and multimeter • Autoset function • Trigger mode: Auto, Free run, Single shot, Edge, Video • 2 cursors • 5 automatic measurements • 4 display image memories • Self-calibration function
Multimeter	<ul style="list-style-type: none"> • Volts, Amps, Ohms, Continuity, Diode, Capacitance measurement • 20A maximum amplitude • True RMS measurement • Isolated inputs between oscilloscope and multimeter
Common	<ul style="list-style-type: none"> • USB interface • 3.8 inch color LCD display, 320 x 240 resolution • 6 hours running time Li-ion battery • 180mm x 113mm x 40mm compact size • 690g light weight

Front Panel and Keys Overview

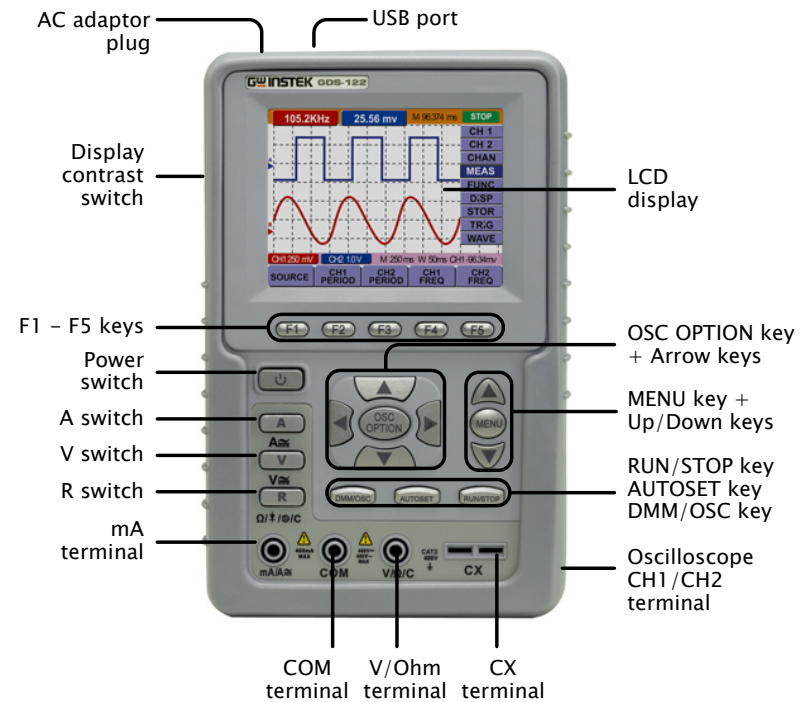

DSO	: Oscilloscope function	DMM	: Multimeter function
AC adaptor plug	Accepts the AC adaptor cord. DC 8.5V, 1500mA.		
USB port	Accepts the USB cable for PC connection.		
LCD display	3.8 inch, 320 x 240 resolution, color LCD display.		
OSC OPTION key + Arrow keys	DSO	Sets the following parameters: vertical level and scale (page21), horizontal level and scale (page24), trigger level (page24), and cursor position (page42).	
MENU key + Up/Down keys	DSO	Activates the side menu and selects the menu items.	
RUN/STOP key	DSO	Manually turns on (run) or off (stop) the trigger. For details, see page24.	

<div style="border: 1px solid black; padding: 2px; display: inline-block;">DSO</div> : Oscilloscope function <div style="border: 1px solid black; padding: 2px; display: inline-block; margin-left: 20px;">DMM</div> : Multimeter function	
RUN/STOP key	<div style="border: 1px solid black; padding: 2px; display: inline-block;">DMM</div> Freezes (stop) or unfreezes (run) the measurement.
AUTOSET key	<div style="border: 1px solid black; padding: 2px; display: inline-block;">DSO</div> Automatically selects the horizontal scale, vertical scale, and trigger level according to the input signal. See page18 for details.
	<div style="border: 1px solid black; padding: 2px; display: inline-block;">DMM</div> Switches the measurement modes. For details, see page87(current), page85(voltage), and page89(impedance).
DMM/OSC key	Switches the operation mode between oscilloscope and multimeter.
CH1/2 terminal	<div style="border: 1px solid black; padding: 2px; display: inline-block;">DSO</div> Accepts the CH1 and CH2 input signal.
CX terminal	<div style="border: 1px solid black; padding: 2px; display: inline-block;">DMM</div> Accepts the test leads for capacitor measurement.
V/ Ω terminal	<div style="border: 1px solid black; padding: 2px; display: inline-block;">DMM</div> Accepts the red lead for voltage, small capacitance, and impedance measurements.
COM terminal	<div style="border: 1px solid black; padding: 2px; display: inline-block;">DMM</div> Accepts the black (ground) lead.
mA terminal	<div style="border: 1px solid black; padding: 2px; display: inline-block;">DMM</div> Accepts the red lead for current measurement.
R switch	<div style="border: 1px solid black; padding: 2px; display: inline-block;">DMM</div> Selects the following measurement: impedance (page89), diode (page91), continuity (page92), capacitance (page93).
V switch	<div style="border: 1px solid black; padding: 2px; display: inline-block;">DMM</div> Selects voltage measurements (page85).
A switch	<div style="border: 1px solid black; padding: 2px; display: inline-block;">DMM</div> Selects current measurements (page87).
Power switch	Turns on or off the GDS-122 power.
F1 – F5 keys	Selects menu items which appear in the bottom of the display.
Display contrast switch	Selects the display contrast: Up (bright) or Down (dark).

Manual Overview

Overview	This user manual is separated in seven chapters. If you want to jump start using the GDS-122, go directly to the <i>Using Oscilloscope</i> or <i>Using Multimeter</i> chapter.
Safety Instructions (page6)	The <i>Safety Instructions</i> gives you an overview of important safety-related issues which you should be aware of before, during, and after operations.
Getting Started (page9)	The <i>Getting Started</i> chapter provides you with the overview of the GDS-122: main features, package contents, front panel, and user manual (this section).
Using the Oscilloscope (page15)	The <i>Using the Oscilloscope</i> chapter describes in detail how to use the GDS-122's oscilloscope functionalities, including the PC software. The chapter starts with simple, basic operations toward more complex measurements and settings. If you are new to the GDS-122, start with the Basic Operations section. For advanced users, the <i>Menu Tree / Shortcuts</i> section shows the menu structures and all operations shortcuts.
Using the Multimeter (page83)	The <i>Using the Multimeter</i> chapter describes how to use the GDS-122's multimeter functionalities. The most commonly used Voltage, Current, and Resistance sections are listed in the front.
Faq (page95)	The <i>Faq</i> chapter lists major problems you might encounter during operations and how to fix or avoid them. Most issues are also listed in the relevant chapters throughout the document.
Specifications (page97)	The GDS-122 specifications are separated in oscilloscope, multimeter, and general parts.
Declaration of conformity (page100)	The <i>Declaration of Conformity</i> chapter lists the safety and EMI/EMC standards to which the GDS-122 conforms.
Index (page101)	The <i>Index</i> chapter lists most of the keywords used in this manual in an alphabetical order.

USING THE OSCILLOSCOPE

This chapter describes the oscilloscope functionalities in the GDS-122: setting it up and measuring simple waveforms, using advanced measurement functions, and configuring the system settings. The menu tree section at the end gives you an overview of all functionalities and a quick access to each of them. For the multimeter functionalities, see page83.

Basic Operations.....	16
Configurations	21
Measurements	39
Advanced Viewings	45
Calibration	51
Saving/Recalling.....	53
Menu Tree / Operation Shortcuts	56
Using the Software.....	61

Basic Operations

Operation flow The *Basic Operations* section describes how to set up the GDS-122 and observe an input signal, step-by-step.

1. Powering up the GDS-122
2. Connecting an input signal
3. Using the Autoset / Introducing the display
4. Adjusting the scales
5. Adjusting the waveform position

Advanced operations For more advanced or detailed operations, see the following chapters.

- *Configurations* (page21)
- *Measurements* (page39)
- *Advanced Viewings* (page45)
- *Calibrations* (page51)

1. Powering up the GDS-122

1. Pressing the power switch Press the power switch. The welcome screen with the corporate logo appears on the display. 

To adjust display brightness, use the switch on the side: up (bright) or down (dark). 

2. Activating the oscilloscope Press any key (for example the MENU (Example) key) to enter the oscilloscope mode. See the battery level icon at the top left corner of the display and connect the power cord if the level is < 25%. 



Switching the operation mode If the multimeter screen appears, press the DMM/OSC key and change the mode to oscilloscope. 

Tilt standing the GDS-122 Use the bar at the back of the GDS-122 to tilt stand it on a horizontal plane.



Note If pressing the power switch does not turn on the GDS-122, the battery may need recharging. Connect the GDS-122 to the AC adaptor and recharge it for at least 15 minutes.

2. Connecting an input signal

1. Connecting the probe Connect the probe(s) between the DUT (Device Under Test) and the CH1/2 inputs on the GDS-122.
2. Setting the probe attenuation To prevent excessive input voltage, we recommend you to set the probe attenuation level to the X 10 position to prevent excessive voltage.

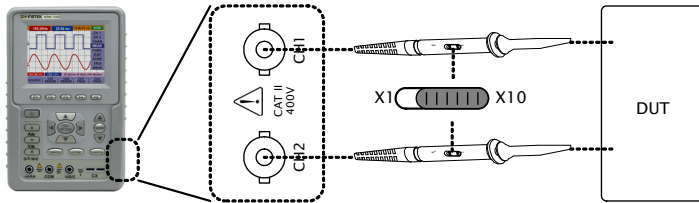

3. Setting the display magnification
 1. After attenuating the probe level by x10, you need to magnify the display level by x10 to balance the signal level. Open the CH1 or CH2 SETUP menu by pressing the MENU key and using the Up/Down keys.
 2. Select the probe attenuation level (10X) by pressing F3 (Probe) repeatedly. The CH1/CH2 vertical scale indicator at the bottom left corner of the display changes accordingly.

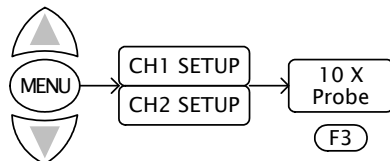

3. Using the Autoset function

Overview The Autoset function automatically configures the following parameters according to the input signal.

- CH1/CH2 on/off
- Vertical scale/level
- Horizontal scale/level
- Trigger level



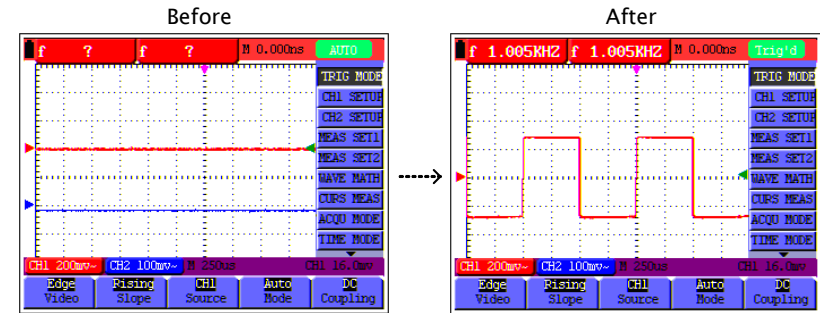

Using the Autoset function Press the AUTOSSET key. The input signal appears in the best display condition.

Example

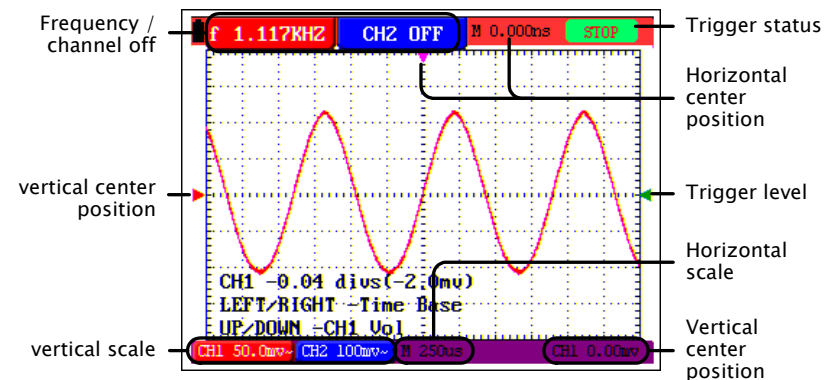

4. Introducing the display contents





- Trigger status
- The signal is triggered 
 - Waiting for trigger conditions 
 - Triggering is stopped 
- Press the RUN/STOP key to control trigger on/off (run/stop). 

5. Adjusting waveform scales

Selecting the menu

Press the OSC OPTION key repeatedly until the following menu appears on the display.

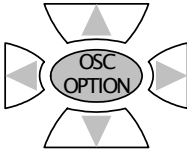
LEFT/RIGHT – Time Base
UP/DOWN – CH1 (or CH2) Vol

Vertical scale Horizontal scale

Adjusting the horizontal scale

Use the Left/Right key to change the horizontal scale.

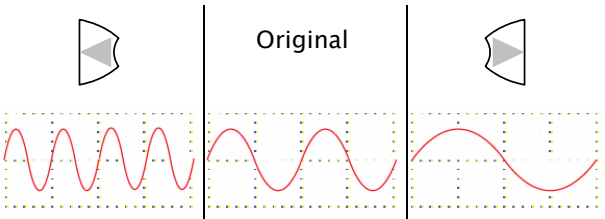

Adjusting the vertical scale

Use the Up/Down key to change the vertical scale.

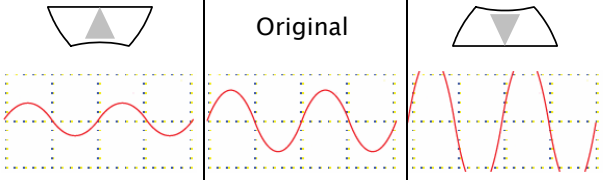

6. Adjusting waveform positions

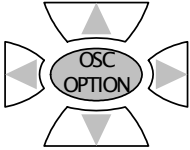
- Selecting the menu
- Press the OSC OPTION key repeatedly until the following menu appears on the display.
- LEFT/RIGHT – Time
UP/DOWN – CH1 (or CH2) Zero
- 

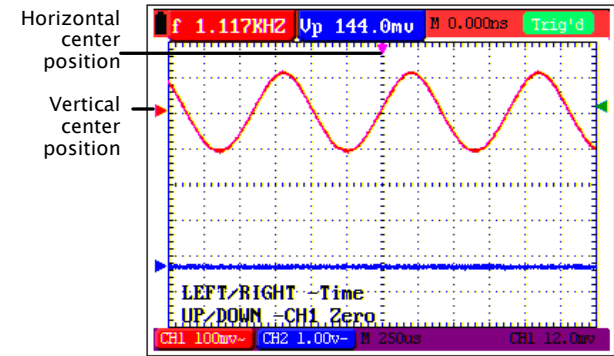

Adjusting the horizontal position

Use the Left/Right key to change the horizontal position.

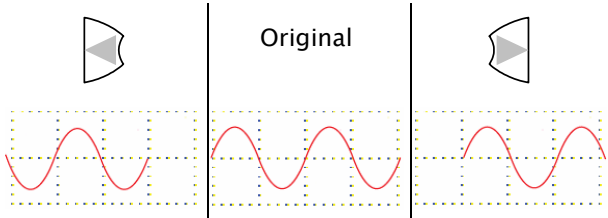

Adjusting the vertical position

Use the Up/Down key to change the vertical position.

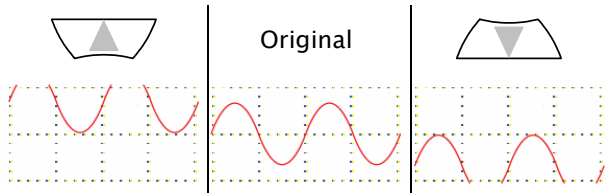

Configurations

Overview	The configuration chapter describes how to change various GDS-122 internal parameters for allowing better measurement condition.	
Configuration items	<ul style="list-style-type: none"> Channel (vertical) settings page21 Horizontal settings page24 Trigger settings page24 Acquisition modes page29 Language page35 Display settings page36 System status (only for viewing) page37 	

Configuring channel (vertical) settings

Overview	The channel settings configure how the waveform appears in terms of vertical or voltage scale.	
Position	Sets the vertical position of the waveform.	
Scale	Sets the vertical scale (volts per graticule). Range: 5mV/div to 5V/div	
CH on/off	Turns the channel on or off.	
Coupling	Selects AC or DC coupling. The DC coupling shows all signal elements, while the AC coupling filters out the DC component from the waveform.	
Inversion	Flips the waveform upside down.	
Magnification	Magnifies the displayed units (does not magnify the real signal). The magnification function is useful to align the displayed with probe attenuation (page17), especially X10.	

Setting the vertical position

1. Press the OSC OPTION key repeatedly until the following menu appears on the display.
LEFT/RIGHT – Time
UP/DOWN – CH1 (or CH2) Zero

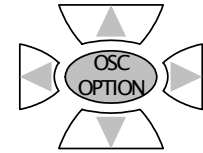

2. Use the Up/Down key to change the vertical position.

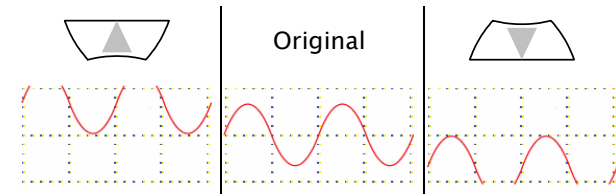

Setting the vertical scale

1. Press the OSC OPTION key repeatedly until the following menu appears on the display.
LEFT/RIGHT – Time Base
UP/DOWN – CH1 (or 2) Vol

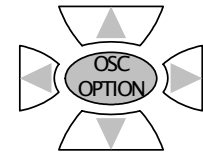

2. Use the Up/Down key to change the vertical scale.

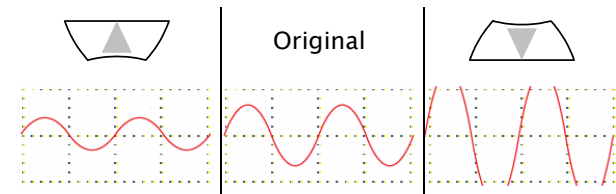

Turning the channel on/off

1. Press the MENU key and use the Up/Down keys to select the CH1(CH2) SETUP menu.
2. Press F2 (Channel) repeatedly to turn on or off the channel.

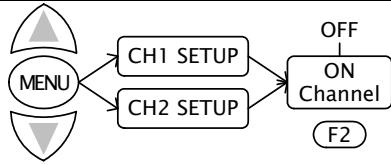

Note that when using the Autoset function (page18), channels are automatically turned on or off.

Selecting the coupling mode

1. Press the MENU key and use the Up/Down keys to select the CH1(CH2) SETUP menu.
2. Press F1 (Coupling) repeatedly to select DC or AC coupling.

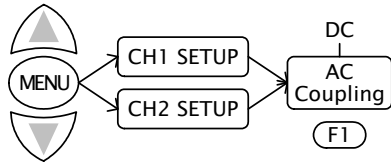

The DC coupling shows both DC and AC signal.

The AC coupling only shows the AC signal.

DC coupling

(center point is at the bottom due to DC offset)

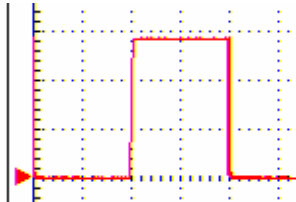

AC coupling

(center point is at the middle since the DC offset is being removed)

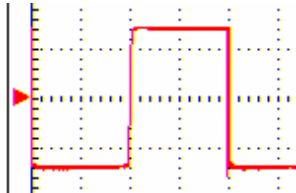

Inverting the channel

1. Press the MENU key and use the Up/Down keys to select the CH1(CH2) SETUP menu.
2. Press F4 (Inverted) to invert the waveform.

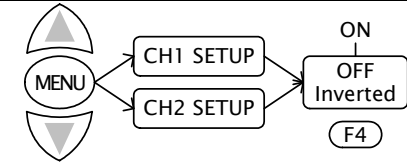

Invert off

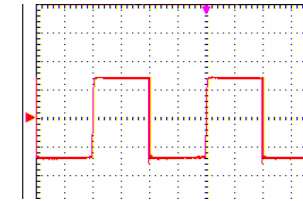

Invert on

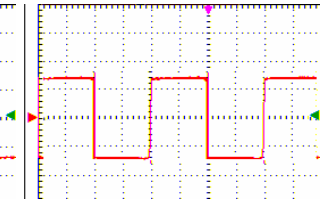

Selecting the magnification

1. Press the MENU key and use the Up/Down keys to select the CH1(CH2) SETUP menu.
2. Press F3 (Probe) repeatedly to select the probe magnification ratio.

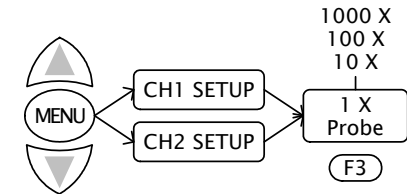

Configuring horizontal settings

Overview

The horizontal settings configure how the waveform appears in terms of horizontal or time scale.

Position Sets the horizontal position of the waveform.

Scale Sets the horizontal scale (time per graticule). Range: 100ms/s to 10s/s

Setting the horizontal position

1. Press the OSC OPTION key repeatedly until the following menu appears on the display.
LEFT/RIGHT – Time

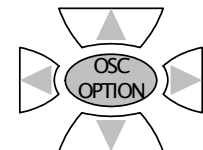



2. Use the Left/Right key to change the horizontal position.

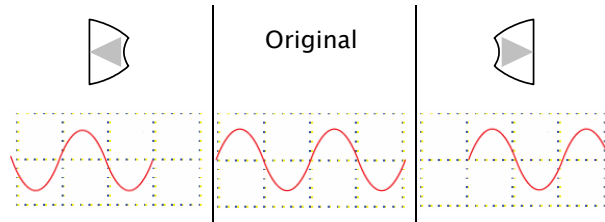

Selecting the horizontal scale

1. Press the OSC OPTION key repeatedly until the following menu appears on the display.

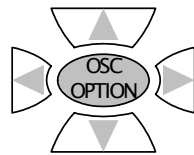
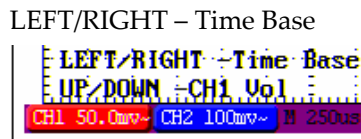

2. Use the Left/Right key to change the horizontal scale.

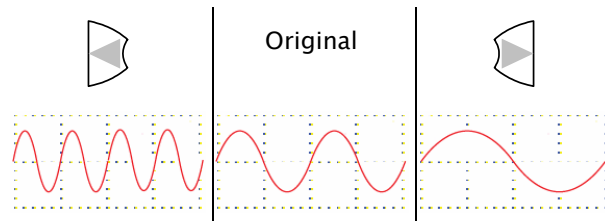

Configuring trigger settings: general settings

Overview

The trigger settings configure how the incoming signal is triggered. The general settings section describes how to start and stop triggering, adjust the level, and change the trigger mode.

- For edge triggering details, see page29.
- For video triggering details, see page32.

Status Shows the triggering status in the icon appearing in the upper right corner of the display.

Run/Stop Controls starting and stopping the trigger.

Level Adjusts the vertical and horizontal level on which the waveforms are triggered.

Trigger status



The trigger status icon is located at the top right corner of the display.

- Trig'd** The trigger condition is met.
- AUTO** The GDS-122 is showing the input signal waveform regardless of trigger condition. Available in the Auto trigger mode in edge triggering (page29).
- Ready** The trigger condition is not met, and the GDS-122 is waiting for the next condition. Available in the Normal trigger mode in edge triggering (page29).
- Scan** The GDS-122 is showing the input signal waveform regardless of trigger condition. The waveform is gradually updated from the left side of the display. The GDS-122 automatically switches to the Scan when the horizontal scale is at 100ms/div or longer.
- STOP** Triggering is stopped regardless of the trigger condition. In order to restart

triggering, you have to press the RUN/STOP key again (in single trigger mode) or switch to another trigger mode.

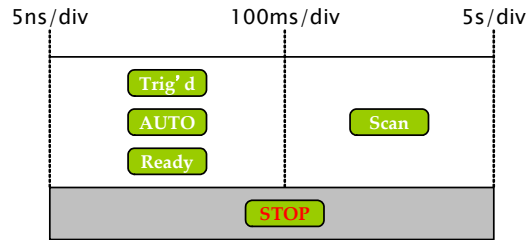
Horizontal scale vs. trigger status



Run/Stop Pressing the Run/Stop key once stops triggering at most situations and changes the trigger icon to STOP.  

In the single trigger mode in edge triggering (page29), pressing the RUN/STOP key works as both activating and deactivating trigger.

Trigger level Press the OSC OPTION key repeatedly until the following menu appears on the display. 

LEFT/RIGHT – Time
UP/DOWN – Trig



Trigger level indicators

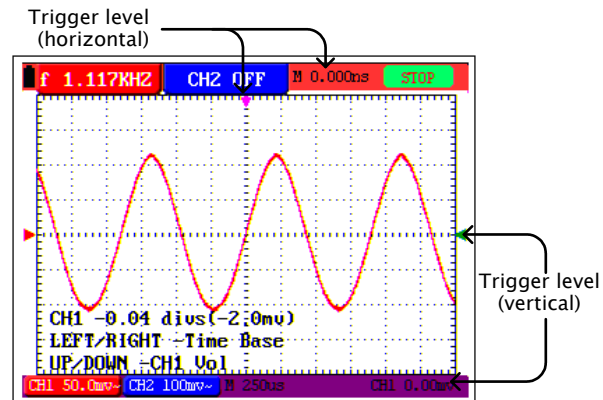

Use the arrow keys to change the triggering position.

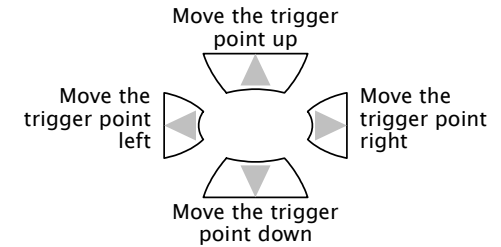

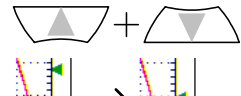
Pressing the Up and Down key together resets the vertical trigger level to zero. 

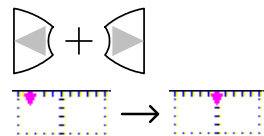
Pressing the Left and Right key together resets the horizontal trigger level to zero. 

Configuring trigger settings: edge triggering

Overview

The edge trigger type triggers on the incoming signal edge. Use the edge trigger for all signals except for video related ones.

- For general trigger settings, see page26.
- For video triggering details, see page32.

To select edge triggering, follow these steps.

1. Press the MENU key and use the Up/Down keys to select TRIG MODE menu.
2. Press F1 (Type) to select the Edge trigger type.

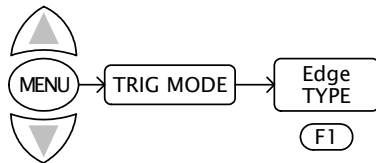

Slope Selects the slope, rising or falling, on which the GDS-122 triggers the input signals.

Source Selects the signal source channel, CH1 or CH2.

Mode Selects the triggering mode, Auto (acquires signal continuously), Normal (acquires signal when trigger conditions are met), and Single (manually triggers the signal).

Coupling Selects the DC or AC coupling and rejection filters: high frequency or low frequency.

Selecting the trigger slope Press F2 (Slope) repeatedly to select the rising or falling slope.

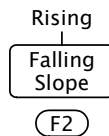

(Continues to the next page)

Example: rising edge

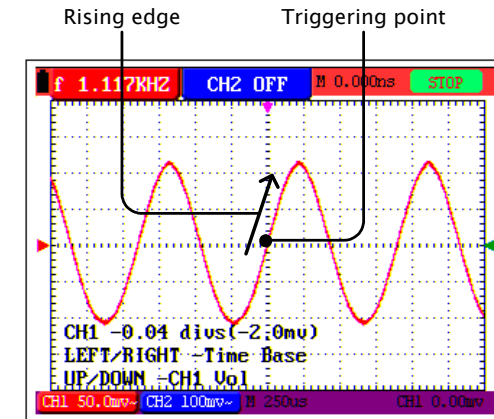

Selecting the source channel

Press F3 (Channel) repeatedly to select the trigger source channel, CH1 or CH2. The trigger channel indicator at the bottom right corner of the display changes.

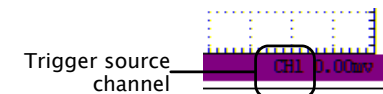
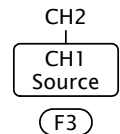

Selecting the trigger mode

Press F4 (Mode) repeatedly to select the trigger mode. The trigger status icon in the upper right corner of the display changes accordingly. For the overview of trigger status in general, see page26.

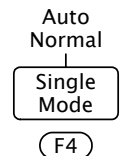

Auto mode

In the auto mode, input signals are constantly acquired and shown in the display regardless of trigger condition.

Horizontal scale (/div)	5ns	100ms	5s
Status icon when triggered	Trig'd	Scan	
Status icon when not triggered	AUTO	Scan	

Normal mode

In the normal mode, input signals are shown in the display only if the trigger condition is met.

Horizontal scale (/div)	5ns	100ms	5s
Status icon when triggered	Trig'd	Scan	
Status icon when not triggered	Ready	Scan	

Single mode

In the single mode, you manually trigger by pressing the RUN/STOP key each time you need to observe the waveform. Once the waveform is captured, the GDS-122 stops triggering and waits for the next trigger command.

Horizontal scale (/div)	5ns	100ms	5s
Status icon when triggered	STOP	STOP	
Status icon when not triggered	AUTO ↕ Ready	Scan	

Selecting the coupling mode

Press F5 (Coupling) repeatedly to select the trigger coupling.

- AC: triggers only on the AC portion of the waveform.
- DC: triggers on the whole waveform (AC + DC).
- LF Rjc: filters out the lower frequency when triggering.
- HF Rjc: filters out the higher frequency when triggering.

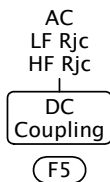

Configuring trigger settings: video triggering

Overview

The video trigger type is designed to capture the video signal format, NTSC, PAL, or SECAM. For any other signal type, use the edge trigger.

- For general trigger settings, see page26.
- For edge triggering details, see page29.

To select edge triggering, follow these steps.

1. Press the MENU key and use the Up/Down keys to select TRIG MODE menu.
2. Press F1 (Type) to select the video trigger type.

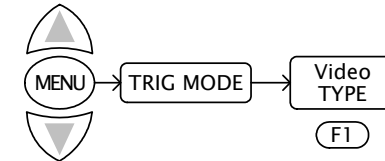

Polarity

Selects the polarity of synchronization signal. Normal means the black level is low. Invert means the black level is high.

Source

Selects the signal source channel, CH1 or CH2.

Sync

Selects the part of the video signal used for synchronization: line or field.

Selecting the trigger polarity

Press F2 (Polarity) repeatedly to select the polarity of synchronization signal.

- Normal: the black level is low.
- Inverted: the black level is high.

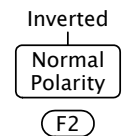

(Continues to the next page)

Selecting the source channel

Press F3 (Channel) repeatedly to select the trigger source channel, CH1 or CH2. The trigger channel indicator at the bottom right corner of the display changes.

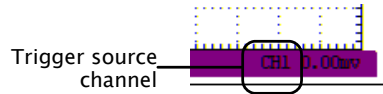
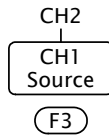

Selecting the sync

Press F4 (Polarity) repeatedly to select the synchronization point.

- Line: the video line is used for triggering.
- Field: the video field is used for triggering.

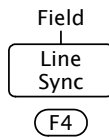

Example

Video line trigger

Video field trigger

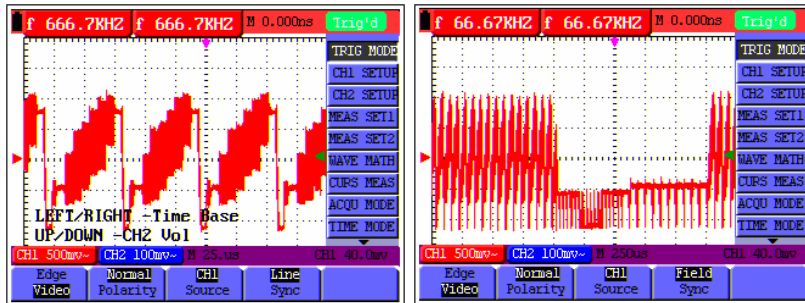

Selecting the acquisition mode

Overview

The acquisition mode specifies how the incoming analog signal is digitally sampled by the GDS-122.

Sample The waveform data is sampled at an equal time interval. The sample mode accurately reconstructs the waveform, but cannot respond to rapid changes and sudden peaks.

Peak detect The maximum and minimum data in the sampling interval are picked up. The peak detect mode captures rapid changes and sudden peaks, but the waveform becomes noisy.

Average Multiple samples are averaged together. The average mode reduces the noise level, but the waveform must be repetitive. The number of averaging are 4, 16, 64, and 128.

Panel operations

1. Press the MENU key and select the ACQU MODE menu using the Up/Down keys.

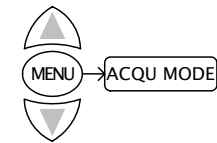

2. Select the acquisition mode from F1 (Sample) to F3 (Average).

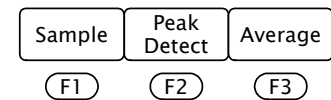

- For the Average mode, also press F4 (Averages) repeatedly to select the number of averaging: 4, 16, 64, or 128.

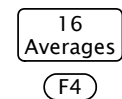

Example

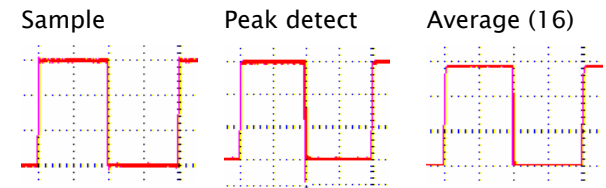

Selecting the language

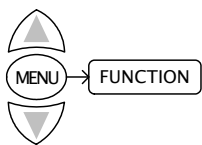
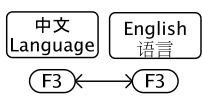
Overview	<p>You can switch the menu language between English and Simplified Chinese. The language settings affect the following areas.</p> <ul style="list-style-type: none"> • Menu bar (right side of the display) • F1-F5 menu (bottom of the display) • System settings screen (page37)
Parameters	English (default), Simplified Chinese
Panel operations	<p>1. Press the MENU key and select the FUNCTION menu using the Up/Down keys.</p>  <p>2. Press F3 (Language) repeatedly to select the language from English or Simplified Chinese.</p>  <p>For other menu items, see the following. F1 (Recall factory): factory settings (page53) F2 (Do Self Cal): self calibration (page51)</p>

Note Recalling the factory settings (Function menu → F1) does not change the language selection.

Configuring display settings

Overview	<p>The display settings configure how the waveforms are drawn in the display.</p> <p>vector drawing The vector drawing mode shows the waveform as a smooth line, connecting each data point.</p> <p>dot drawing The dot drawing mode shows the waveform as a collection of independent data points.</p> <p>persistence The persistence setting sets how long the old waveforms remain in the display, useful for observing the waveform variations.</p>
----------	--

Panel operations

1. Press the MENU key and use the Up/Down keys to select the DISP SET menu.
2. Press F1 (Type) or F2 (Persist) repeatedly to select vector drawing, dot drawing, and persistence time.

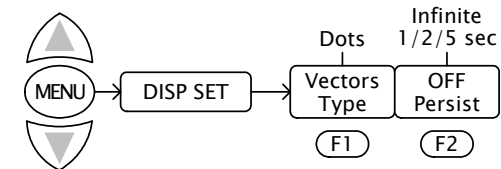

Vector/dot drawing example

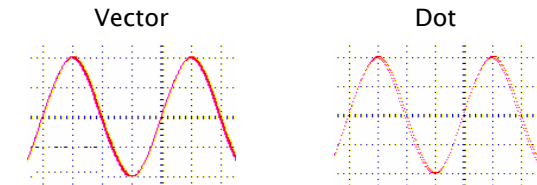

Persistence example

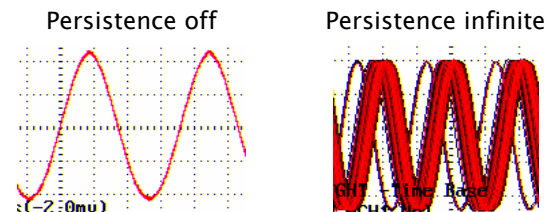

Viewing the system status

Overview The system status menu shows the GDS-122 system settings.

Panel operations 1. Press the MENU key and select the SYS STAT menu using the Up/Down keys.

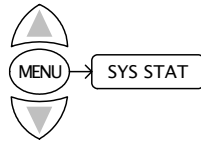

2. Select the status menu from F1 (Horizontal) to F4 (Misc) and press it. The status information appears in the display.

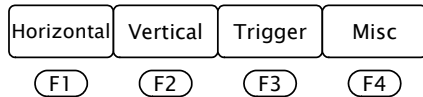

3. To close the system status screen, select different menus using the MENU key followed by Up/Down keys.



Horizontal status (F1)

HORIZONTAL SYSTEM STATUS	
TIME BASE	MAIN TIME BASE
MAIN SCALE	1.0ms
WINDOW SCALE	10.us
MAIN POSITION	300.0us
WINDOW POSITION	559.60us
DISPLAY FORMAT	YT
ACQUIRE MODE	SAMPLE

For details of each item, see the following pages.

Time base: page24

Main/window scale: page45

Main/window position: page45

Display format: page47 (XY)

Acquire mode: page34

(Continues to the next page)

Vertical status (F2)

VERTICAL SYSTEM STATUS		
SCALE	CH1	2.00v
SCALE	CH2	50.0mv
POSITION	CH1	0.00 divs(0.0mv)
POSITION	CH2	0.00 divs(0.0mv)
COUPLING	CH1	DC
COUPLING	CH2	DC
PROBE	CH1	1X
PROBE	CH2	1X
MATH	CH1-CH2	
INVERTED	CH1	OFF
INVERTED	CH2	OFF

For details of each item, see the following pages.

CH1/CH2 scale: page21

CH1/CH2 position: page21

CH1/CH2 coupling: page21

CH1/CH2 probe: page21

Math mode: page39

CH1/CH2 invert: page21

Trigger status (F3): Edge trigger

TRIGGER SYSTEM STATUS	
TYPE	EDGE
SOURCE	CH1
SLOPE	RISING
TRIGMODE	SINGLE TRIGGER
COUPLING	DC

For details of each item, see the following pages.

Trigger type: page29

Trigger source: page29

Trigger slope: page29

Trigger mode: page29

Trigger coupling: page29

Trigger status (F3): Video trigger

TRIGGER SYSTEM STATUS	
TYPE	VIDEO
SOURCE	CH1
POLARITY	NORMAL
SYNC	LINE

For details of each item, see the following pages.

Trigger type: page32

Trigger source: page32

Trigger polarity: page32

Trigger sync: page32

Misc status (F4)

MISC
GW INSTEK
Series Number
W102206150095

The Misc status shows the manufacturer name and the serial number.

Measurements

Overview The advanced measurement functions allow you to automatically measure various parameters in a waveform.

- | | | |
|--------------------------|------------------------------|--------|
| Measurement items | • Waveform math | page39 |
| | • Automatic measurements | page41 |
| | • Time cursor measurement | page42 |
| | • Voltage cursor measurement | page43 |

Running waveform maths

Overview The waveform math function runs mathematical operations between CH1 and CH2 waveform, and then shows the result in the display.

- Math type**
- CH1 – CH2 (subtract CH2 from CH1)
 - CH2 – CH1 (subtract CH1 from CH2)
 - CH1 + CH2 (add CH1 and CH2)
 - CH1 * CH2 (multiply CH1 and CH2)
 - CH1 / CH2 (divide CH1 by CH2)

Panel operations 1. Make sure that both CH1 and CH2 waveforms are shown in the display.

2. Press the MENU key and select the WAVE MATH menu using the Up/Down keys.

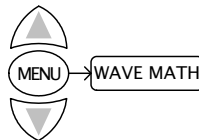

3. Select the math operation from F1 (CH1 – CH2) to F5 (CH1 / CH2) and press it.

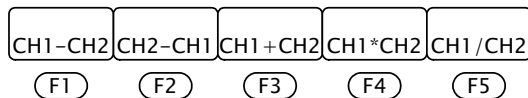

4. The math result appears in the display (example: adding two square waveforms)

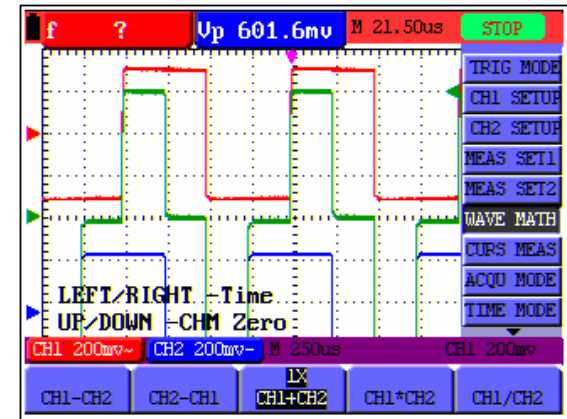

5. To cancel the math result, press the function key (F1 to F5) again.

Changing the math result position

1. Press the OSC OPTION key. Make sure the following menu appears on the display.

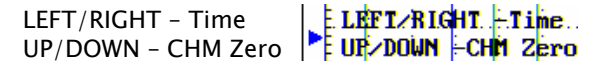

2. Use the arrow keys to move the math result position.

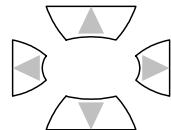

Changing the math result scale

1. Press the OSC OPTION key repeatedly until the following menu appears on the display.

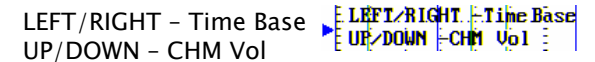

2. Use the arrow keys to change the math result scale.

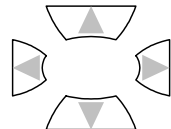

Saving or recalling the math result

The math result waveform can be saved into or recalled from one of the four GDS-122 internal memories. See page53 for details.

Running automatic measurements

Overview	The automatic measurement function measures the input signal's characteristics and lists them in the top left corner of the display.
Source signal	CH1, CH2
Measurement set	SET1, SET2
Measurement items	<p>The following measurement items are available.</p> <ul style="list-style-type: none"> • Frequency • Period • Mean voltage • Peak-to-peak voltage • Cycle voltage (true RMS)

Panel operations 1. Make sure that the waveform appears.

2. Press the MENU key and select the MEAS SET1 or SET2 menu using the Up/Down keys. SET1 and SET2 correspond to the results in the upper left corner of the display.

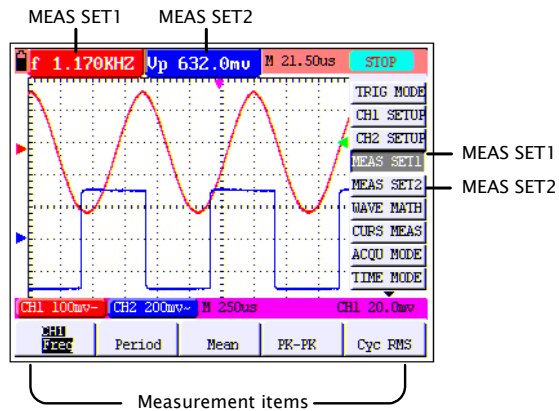
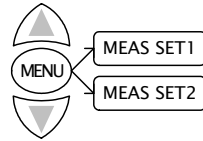

3. Select the measurement type from F1 (Freq) to

F5 (Cyc). Press it repeatedly to select CH1 or 2.

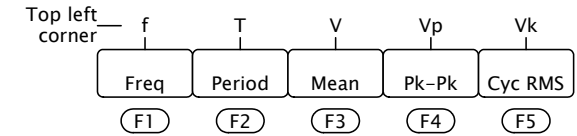

4. The measurement result appears in the top left corner of the display.

Running time cursor measurements

Overview	<p>The time cursor function measures and updates the following three types of time difference.</p> <ul style="list-style-type: none"> • Between cursor 1 and cursor 2 • Between cursor 1 and center (zero) point • Between cursor 2 and center (zero) point
----------	--

Time cursor panel operations 1. Make sure that the waveform appears.

2. Press the MENU key and select the CURS MEAS menu using the Up/Down keys.

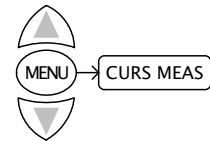

3. Press F1 (Type) repeatedly to select the Time cursor. The cursors appear as vertical purple lines located at the center of the display.

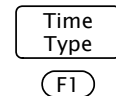

4. Press the OSC OPTION key repeatedly until the following menu appears.



LEFT/RIGHT - Time
UP/DOWN - Cursor 1(or Cursor2)

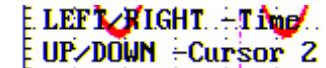

5. Use the arrow keys to move the cursor or horizontal position.

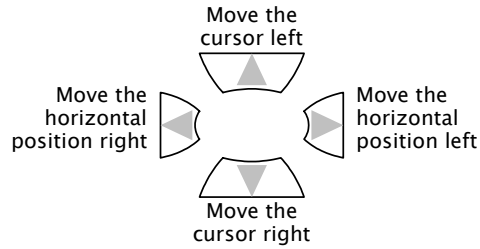

Display overview
(CH1, cursor 2)

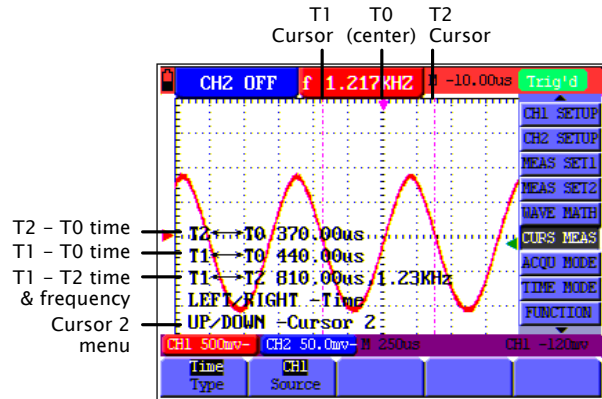

Running voltage cursor measurements

Overview The voltage cursor function measures and updates the following five types of voltage difference.

- Between cursor 1 and cursor 2
- Between cursor 1 and CH1 center point
- Between cursor 2 and CH1 center point
- Between cursor 1 and CH2 center point
- Between cursor 2 and CH2 center point

Source signal CH1 input, CH2 input

- Voltage cursor panel operations**
1. Make sure the waveform appears.
 2. Press the MENU key and select the CURS MEAS menu using the Up/Down keys.

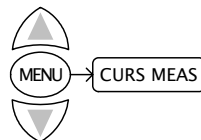

3. Press F1 (Type) repeatedly to select the Voltage cursor. The cursors appear as horizontal purple lines located at the center of the display.

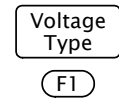

4. Press F2 (Source) repeatedly to select the source channel.

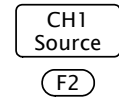

5. Press the OSC OPTION key repeatedly until the following menu appears.



LEFT/RIGHT - Time
UP/DOWN - Cursor V1
(or Cursor V2)

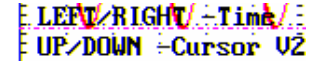

6. Use the arrow keys to move the cursor or horizontal position.

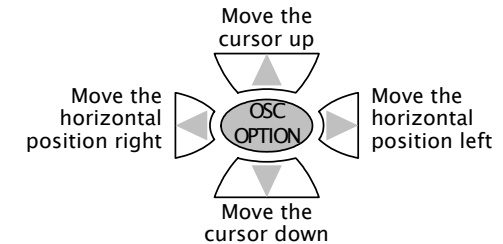

Display overview
(CH1, cursor 2)

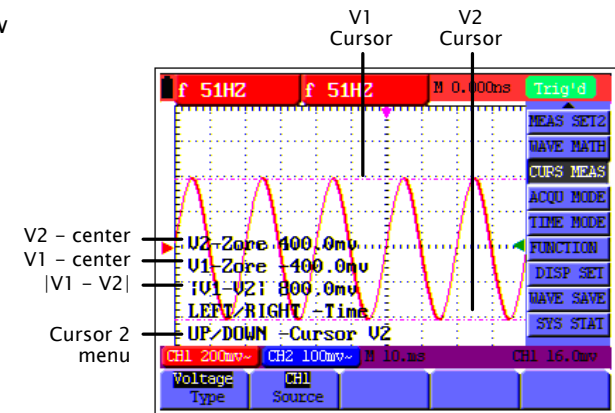

Advanced Viewings

Overview The advanced viewing functions allow you to clearly observe specific type of waveforms and/or particular characteristics in a waveform.

- | | |
|---------------|--|
| Viewing items | <ul style="list-style-type: none"> • Waveform zoom page45 • X-Y format page47 • Signal peaks page48 • Noisy signals page48 • Variations in a signal page49 |
|---------------|--|

Zooming waveforms horizontally

Overview By using the zoom function, you can magnify the waveform in the horizontal direction.

Panel operations 1. Make sure that the waveform appears in the display.

2. Press the MENU key and select the TIME MODE menu using the Up/Down keys.

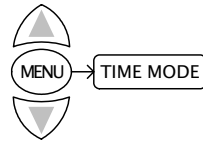

3. Press F2 (Set Window). A set of cursors appears in the center of the display.

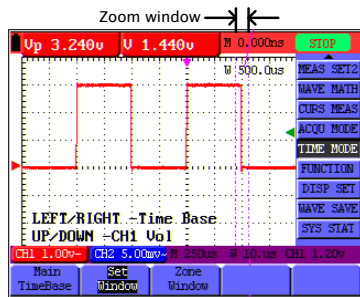

4. Press the OSC OPTION key repeatedly until the Time



Base menu appears.

Cursor 1 menu

5. Use the arrow keys to change the zoom width.

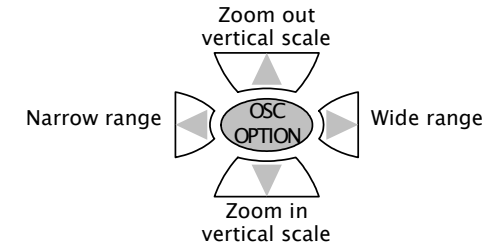

6. Press F3 (Zone Window) to zoom into the window.

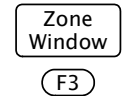

Example

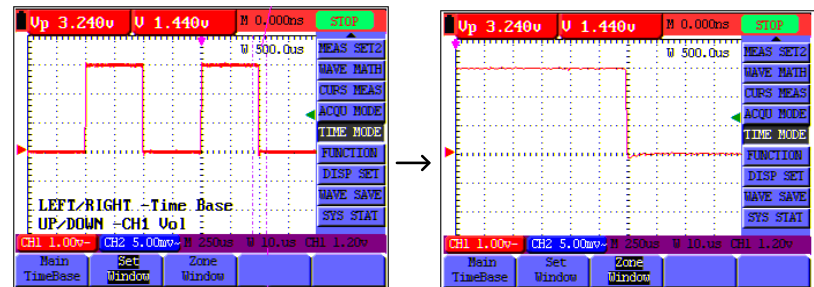

Viewing waveforms in X-Y format

Overview The X-Y format plots the CH1 input as X-axis and CH2 input as Y-axis. This display mode is convenient for viewing the phase relationship between CH1 and CH2.

Panel operations 1. Make sure that both CH1 and CH2 waveforms appear in the display.

2. Press the MENU key and select the DISP SET menu using the Up/Down keys.

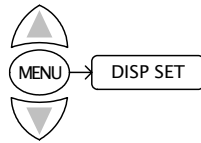

3. Press F3 (Format) and select XY. The display mode switches into the X-Y format.

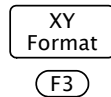

Changing the scale and position Press the OSC OPTION key repeatedly to access the menu listed below. In the X-Y mode, all scales and positions are controlled by the Up/Down keys.

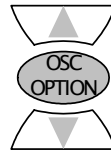

- CH1 Zero: horizontal position
- CH2 Zero: vertical position
- CH1 Vol: horizontal scale
- CH2 Vol: vertical scale

Functions not applicable in the X-Y format The following functions do not work in the X-Y format.

- Cursor measurement (page42, page43)
- Automatic measurement (page41)
- Window zoom (page45)
- Trigger settings configuration (page24)

Viewing signal peaks

Overview Using the peak detect acquisition mode, the maximum and minimum data in the sampling interval are displayed, capturing the rapid changes and sudden peaks that might spontaneously occur in a waveform.

Note Since the peak detect mode picks up the most extreme data, the waveform becomes noisier than the normal acquisition mode (sampling mode).

Panel operations 1. Press the MENU key and use the Up/Down keys to select ACQU MODE menu.
2. Press F2 (Peak Detect) to activate the peak detect mode.

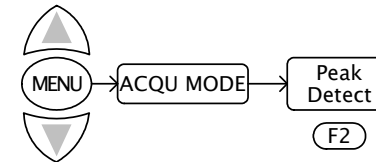

For other acquisition settings details, see page29.

Example

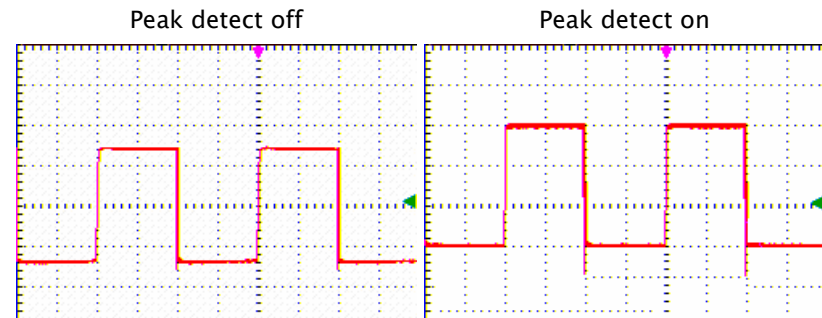

Viewing noisy signals

Overview Using the Average acquisition mode, you can smooth out the displayed waveform by averaging multiple data samples. The number of averaging is selectable from 4, 16, 64, and 128.

- Note**
- In order for the average mode to work in the best way, the waveform must be repetitive.
 - As the number of averaging increases, the slower the waveform update becomes.

- Panel operations**
1. Press the MENU key and use the Up/Down keys to select ACQU MODE menu.
 2. Press F3 (Average) to activate the average mode.
 3. Press F4 (Averages) repeatedly to select the number of averaging.

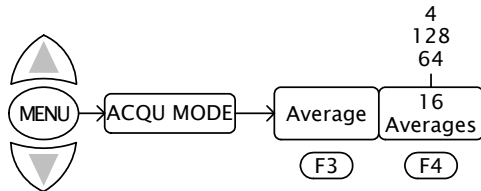

For other acquisition settings details, see page29.

Example

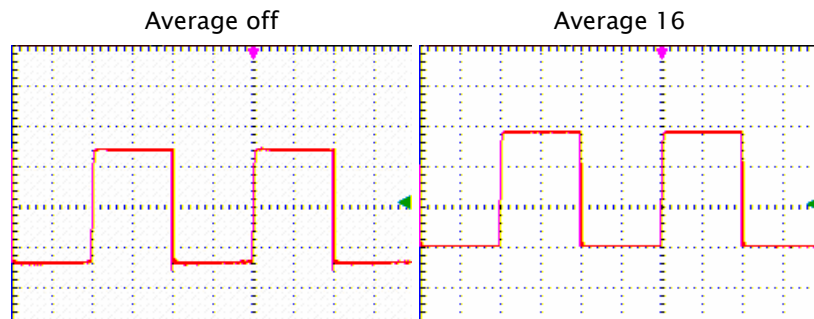

Viewing variations in a signal

Overview Using the persistence display function, you can define sets how long the old waveforms remain in the display, allowing observation of waveform variations. You can select the persistence time from 1, 2, and 5 sec. When choosing the Infinite mode, the GDS-122 keeps all past traces of the displayed waveform.

- Panel operations**
1. Press the MENU key and use the Up/Down keys to select DISP SET menu.
 2. Press F2 (Persist) repeatedly to select the persistence time.

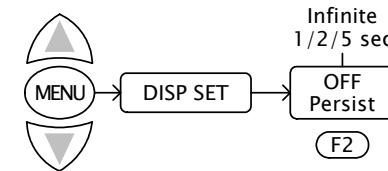

For other display settings details, see page36.

Example

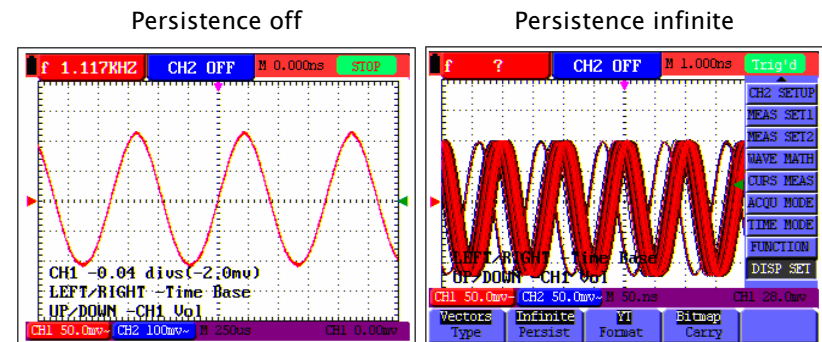

Calibration

Overview Two types of calibrations are available: self-calibration and probe calibration. The self calibration automatically adjusts GDS-122 internal parameters. The probe calibration adjusts the probe capacitance. You should run both whenever using the GDS-122 in a new environment.

Running the self calibration

Overview The self calibration function automatically configures internal parameters to maintain the sensitivity and accuracy. Run the self calibration in the following cases.

- When the temperature fluctuates more than 5 degrees Celsius during operations
- When operating the GDS-122 in a new benchtop or field environment

Procedures 1. Press the MENU key and select the FUNCTION menu using the Up/Down keys.

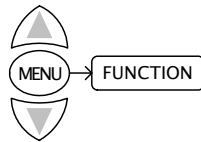

2. Press F2 (Do Self Cal). A message appears on the display, asking you to remove all cables and probes from the GDS-122.

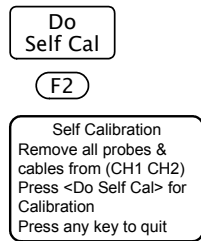

3. After removing all cables, press F2 (Do Self Cal) again. The self-calibration automatically starts and a message appears, showing that the calibration is ongoing.

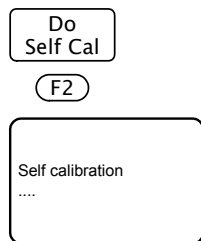

4. When the message disappears in 5 minutes, the calibration is completed.

To interrupt calibration Press any key during calibration.

Running the probe calibration

Overview The attached probe contains a calibration point at the end to adjust the waveform.

Procedures 1. Select a rectangular waveform as the signal input. Use the Autoset function and put the waveform in the middle of the display. AUTOSSET

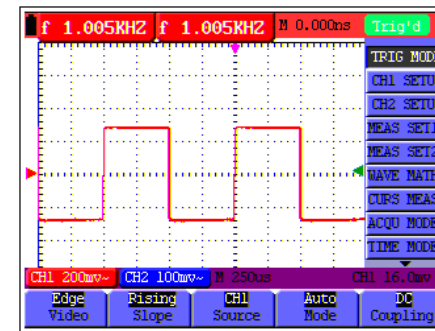

2. Adjust the probe calibration point to make sure that the waveform edge remains flat.

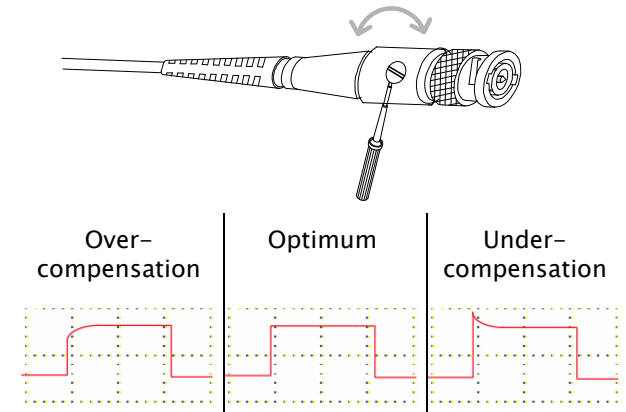

Saving/Recalling

Overview The GDS-122 can save or recall four sets of waveforms using its internal memory. When you need to reset the system, recall the default (factory installed) settings.

- | | | |
|-------------------|------------------------------|--------|
| Save/recall items | • Recalling default settings | page53 |
| | • Saving waveforms | page54 |
| | • Recalling waveforms | page55 |

Recalling the default settings

Recalling the default settings You can recall the default factory settings by pressing the MENU key, then selecting FUNCTION → F1 (Recall Factory).

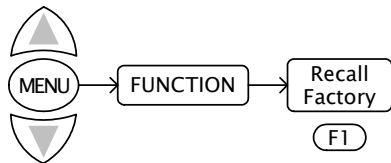

Trigger	Type: Edge Source: CH1 Coupling: AC	Slope: Rising Mode: Auto
CH1 & CH2	Coupling: AC Probe scaling: 1 X	Channel: ON Invert: OFF
Measurement 1	Item: CH1 frequency	
Measurement 2	Item: CH2 frequency	
Cursor	Cursor: OFF	Channel: CH1
Acquisition	Mode: Sample	Average number: 16
Time mode	Mode: Main timebase	
Display	Type: Vector Format: YT	Persistence: OFF Carry: Bitmap
Wave Save	Source: CH1 Display: OFF	Waveform: A

Saving waveforms

Overview Up to four waveforms can be stored in and recalled from the GDS-122 internal memory. The stored waveform can be used for reference, comparison xxxxxxxx.

Memory Four memories: waveform A, B, C, and D.

Source CH1, CH2, Math waveform

Panel operations 1. Make sure the waveform you want to save (CH1, CH2, or Math result) appears in the display. For Math operations details, see page39.

2. Press the MENU key and select the WAVE SAVE menu using the Up/Down keys.

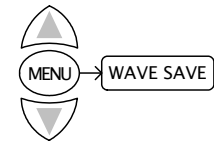

3. Press F1 (Source) repeatedly and select the waveform source.

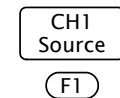

4. Press F2 (WAVE) repeatedly and select the memory location from A to D.

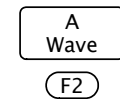

5. Press F3 (Save) to confirm saving the waveform into the specified memory location. Make sure that the message "WAVE SAVE SUCCEEDED" appears in the display.



WAVE SAVE SUCCEEDED

Recalling waveforms

Overview	Up to four waveforms can be stored in and recalled from the GDS-122 internal memory. The stored waveform can be used for reference, comparison xxxxxxxx.
Memory	Four memories: waveform A, B, C, and D.
Source	CH1, CH2, Math waveform

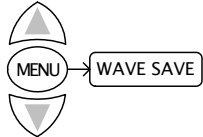
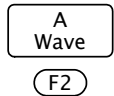
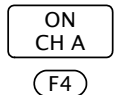
- Panel operations
1. Press the MENU key and select the WAVE SAVE menu using the Up/Down keys.
 
 2. Press F2 (Wave) repeatedly and select the waveform you want to recall.
 
 3. Press F4 and turn ON the waveform. The waveform appears in the display.
 

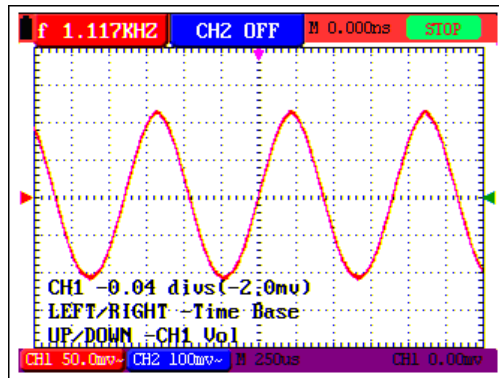

Note The recalled waveform maintains its original horizontal scale and vertical scale, which are shown in the top left corner of the display. Changing the current scale does not affect the recalled waveform's shape.

Menu Tree / Operation Shortcuts

Accessing menus The following menu trees are accessible by pressing the MENU key followed by Up/Down keys, except for the OSC OPTION key (page60).



Trigger

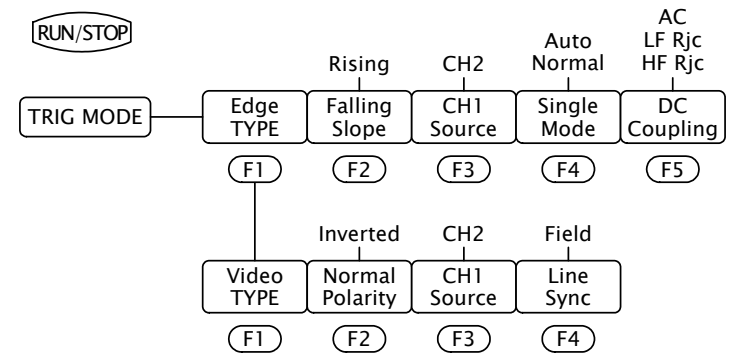

Select run or stop mode	RUN/STOP key
Select edge or video trigger	TRIG MODE→F1 (TYPE)
Select trigger slope	TRIG MODE→F1 (edge)→F2 (Slope)
Select trigger source	TRIG MODE→F1→F3 (Source)
Select trigger mode	TRIG MODE→F1 (edge)→F4 (Mode)
Select trigger coupling	TRIG MODE→F1 (edge)→F5 (Coupling)
Select video polarity	TRIG MODE→F1 (video)→F2 (Polarity)
Select video line sync	TRIG MODE→F1 (video)→F4 (Sync)

CH1 /CH2 Setup

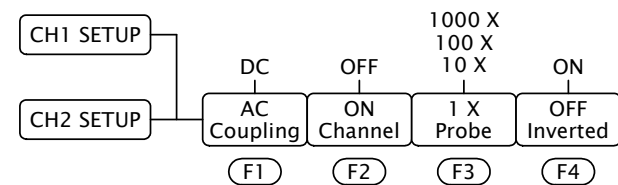

Select AC or DC coupling	CH1 /2 SETUP→F1 (Coupling)
--------------------------	----------------------------

Turn CH1 on or off	CH1 /2 SETUP→F2(Channel)
Select probe scaling	CH1 /2 SETUP→F3(Probe)
Turn inversion on or off	CH1 /2 SETUP→F4(Inverted)

Measurement Setup 1 / 2

Measure CH1 /CH2 frequency	MEAS SET1 / 2→F1(Freq)
Measure CH1 /CH2 period	MEAS SET1 / 2→F2(Period)
Measure CH1 /CH2 mean value	MEAS SET1 / 2→F3(Mean)
Measure CH1 /CH2 peak to peak time	MEAS SET1 / 2→F4(Pk-Pk)
Measure CH1 /CH2 cycle	MEAS SET1 / 2→F5(Cyc RMS)

Wave Math

Subtract CH2 from CH1	WAVE MATH→F1(CH1-CH2)
Subtract CH1 from CH2	WAVE MATH→F2(CH2-CH1)
Add CH2 to CH1	WAVE MATH→F3(CH1+CH2)
Multiply CH2 with CH1	WAVE MATH→F4(CH1*CH2)
Divide CH1 by CH2	WAVE MATH→F5(CH1/CH2)

Cursor Measurement

Activate cursor measurement	CURS MEAS→F1(Type)
Select source channel	CURS MEAS→F2(Source)

Acquisition Mode

Select sampling mode	ACQU MODE→F1(Sample)
Select peak detect mode	ACQU MODE→F2(Peak Detect)
Select average mode	ACQU MODE→F3(Average)
Select average number	ACQU MODE→F3→F4(Averages)

Time Mode

Select main timebase	TIME MODE→F1(Main TimeBase)
Set window zoom width	TIME MODE→F2(Set Window)
Zoom window	TIME MODE→F3(Zone Window)

Function

Recall factory settings	FUNCTION→F1(Recall Factory)
Run self calibration	FUNCTION→F2(Do Self Cal)
Select language	FUNCTION→F3(Language)

Display

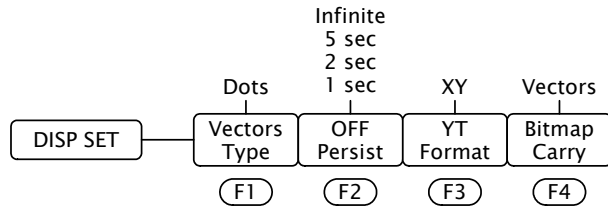

Select line display	DISP SET→F1 (Type)
Select persistency	DISP SET→F2 (Persist)
Select display format	DISP SET→F3 (Format)
Select display save format	DISP SET→F4 (Carry)

Wave Save

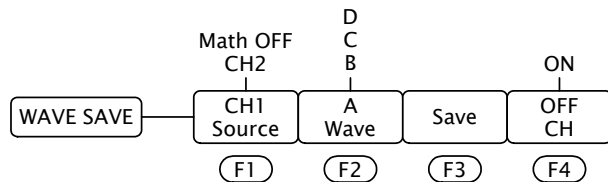

Select source channel	WAVE SAVE→F1 (Source)
Select waveform ID	WAVE SAVE→F2 (Wave)
Save waveform	WAVE SAVE→F3 (Save)
Turn waveform display on or off	WAVE SAVE→F4 (CH A/B/C/D)

System Status

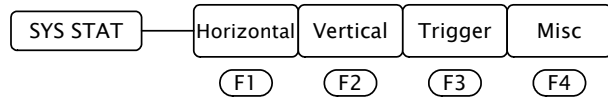

Show horizontal settings	SYS STAT→F1 (Horizontal)
Show vertical settings	SYS STAT→F2 (Vertical)
Show trigger settings	SYS STAT→F3 (Trigger)
Show serial number	SYS STAT→F4 (Misc)

OSC OPTION key

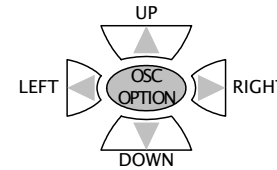

Press the OSC OPTION key repeatedly. The menu message appears in the lower half of the display and the functionalities of four keys, UP, DOWN, RIGHT, LEFT, change accordingly.

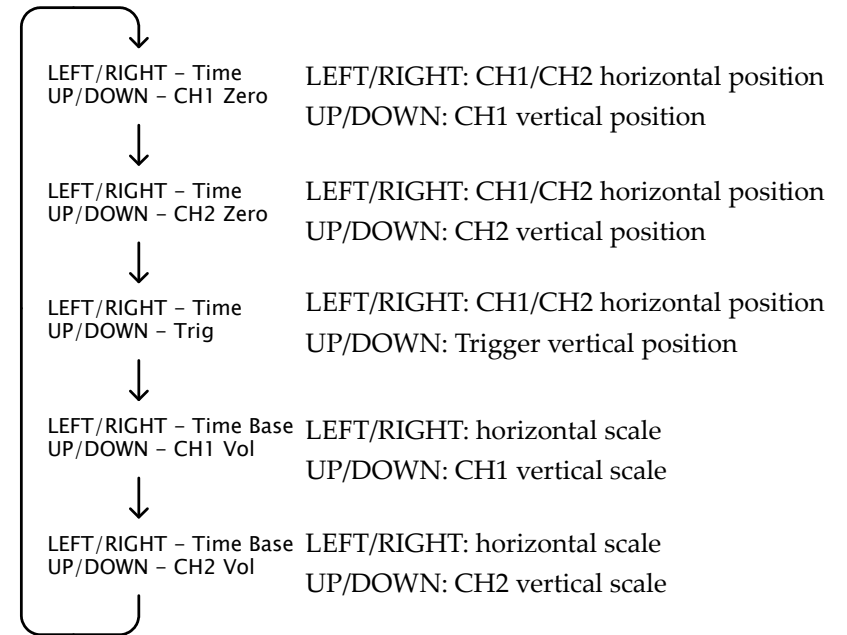
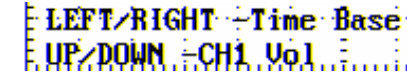

(Math mode)	(Math mode)
LEFT/RIGHT - Time	LEFT/RIGHT: Math horizontal position
UP/DOWN - CHM Zero	UP/DOWN: Math vertical position

(Cursor mode)	(Cursor mode)
LEFT/RIGHT - Time	LEFT/RIGHT: CH1/CH2 horizontal position
UP/DOWN - Cursor 1/2	UP/DOWN: Cursor 1/2 vertical position

Using the Software

Overview The GDS-122 PC software, included in the CD-ROM, allows you to view the waveforms in your familiar PC environment – large display and mouse operation. Multiple cursors provide flexible waveform measurements.

Software functionalities The PC software can run the following measurement and actions.

- Viewing real-time updated waveforms
- Running up to 6 cursor measurements
- Measuring period/frequency/pk-pk voltage
- Printing out waveform images
- Saving and recalling waveform shape and data

Software operations The following is the list of software operations described in this chapter.

• Installing the software	page62
• Modifying, reinstalling, or uninstalling the software	page64
• Connecting the GDS-122	page65
• Configuring the screen	page68
• Viewing waveforms	page69
• Measuring waveforms	page75
• Saving waveforms	page75
• Recalling waveforms	page77
• Printing out waveforms	page80
• Accessing the Help	page82

Note The PC software is intended for oscilloscope operations only; it does not include multimeter operations.

Installing the software

- PC requirements**
- Windows 2000 or XP
 - 20MB hard drive space
 - USB host port x 1

Installation steps 1. Activate the Setup.exe file in the CD-ROM.



2. The language selection window appears. Select the software language and click *OK* (you can later change the language manually).

English Simplified Chinese
 英語 (美國) Chinese (Simplified)

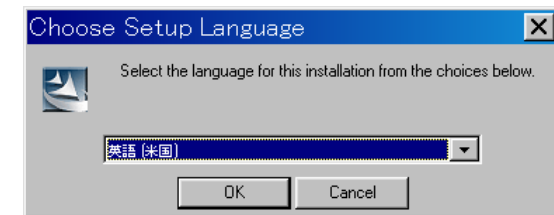

3. The software starts preparing the installation. When the welcome window is displayed, click *Next* and start installing the software to your PC.



4. The customer information window will appear. Enter the user name and organization name. Select which user will hold the right to access the software and click *Next*.

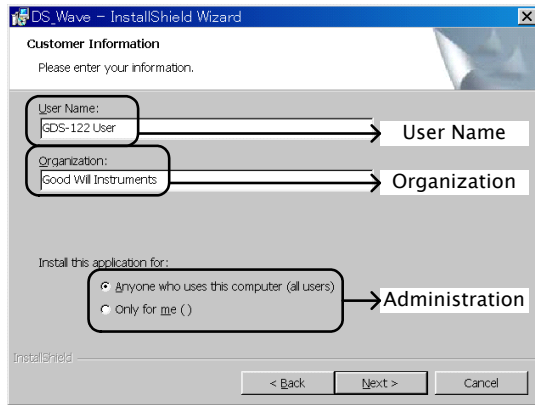

5. Change the installation directory if necessary and click *Next*.

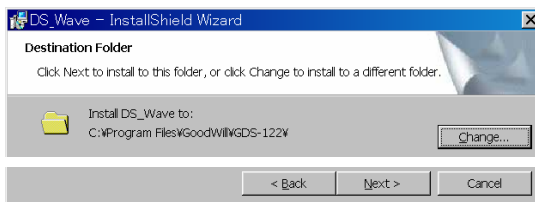

6. Click *Install* to start installing the software.

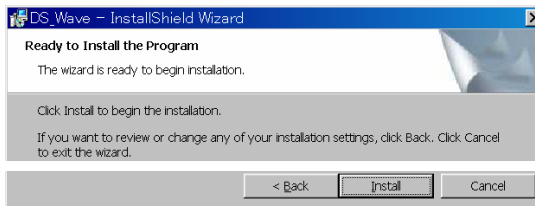

7. The software installation automatically starts and ends. Click *Finish* to complete installation.

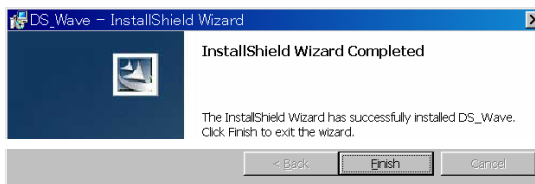

Installing the software is completed

Modifying/Reinstalling/Uninstalling the software

Overview After installing the software, you can do the followings using the same setup file.

- Modifying the software components
- Repairing the software
- Uninstalling the software

Steps 1. Activate the Setup.exe. Follow the same procedures as installing the software until the *Program Maintenance* window appears.

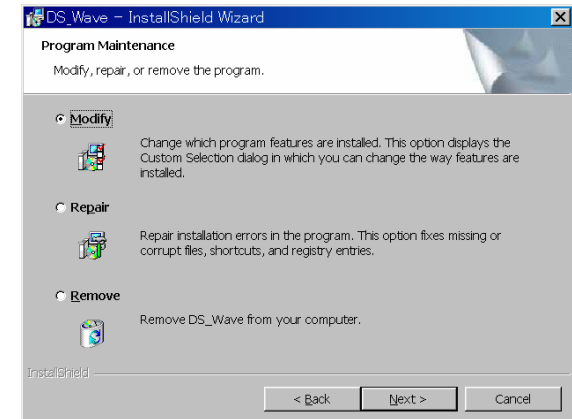

2. Select the action – *Modify* the software components, *Repair* the software, or *Remove* (uninstall) the software – and click *Next*. Proceed according to the instructions.

Shortcut for uninstall

Alternatively, you can select the Uninstall DC_Wave from the program startup menu to uninstall the software.

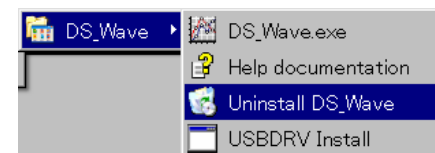

Activating the software and connecting the GDS-122

- Overview** Activate the software and connect the GDS-122 to it properly by going through these steps, described in the paragraphs that follow.
1. Activating the software and configuring the communication port
 2. Activating the GDS-122 and configuring the data format
 3. Connecting them together and if necessary, installing the USB driver
 4. Acquiring waveform data to confirm that the communication is being secured

Activating the software

1. Open the software by selecting DS_Wave.exe from the startup menu.
2. Select Communications – Ports Settings from the menu or click the Ports-settings icon on the Toolbar.

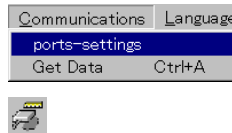

Make sure that USB connection is being selected. The baud rate, stop bit, data bit, and parity settings are fixed.

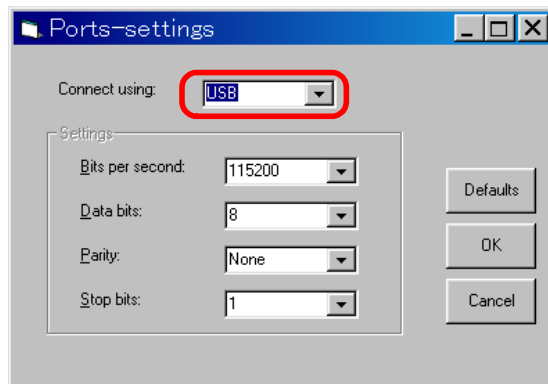

Activating the GDS-122

1. Power up the GDS-122 and activate the oscilloscope screen.
2. Connect an input signal to CH1 and make sure that the waveform is shown appropriately on the GDS-122 display.
3. Open the DISP SET menu and press F4 (Carry) to select the format of the waveform data sent from the GDS-122 to the software.

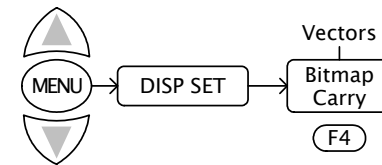

- Vectors** Vectored data of the waveform. Always select the vector format when viewing the waveform in the software.
- Bitmap** Bitmap image of the display. Select the Bitmap format only when taking the bitmap snapshot of the GDS-122 hardware screen.

Connecting the cable

1. Connect the GDS-122 to the PC (software) via the USB cable.
2. Make sure that the USB driver is installed in your PC by accessing the Device Manager (Control Panel -> System -> Hardware tab). The GDS-122 should be recognized as a USB hub.

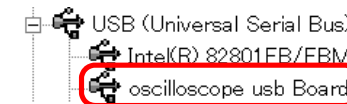

3. If the driver has not been recognized, install it manually by selecting USBDRV Install from the startup menu.



The driver file is located in the USBDRV folder in the software directory.

Acquiring data

In the software, select **Communications – Get Data** from the menu. Alternatively, you may click the Get data icon, or press the Ctrl + A key.

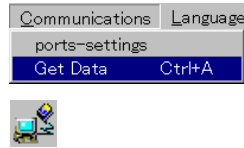

Acquiring the GDS-122 display snapshot

When the “Bitmap” format is selected in the GDS-122 display carry setting, the software acquires the display snapshot (*.bmp) at the moment. Save the file in the local folder and use a graphic software to open and edit it.

Acquiring the GDS-122 waveform

When the “Vectors” format is selected in the GDS-122 display carry setting, the software acquires the waveform data (*.bin) at the moment.

1. The waveform data will be stored in the PC memory to allow to be recalled later (page79). Edit the location and click Start.

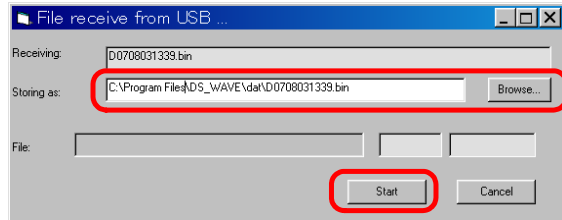

2. The waveform appears in the software screen.

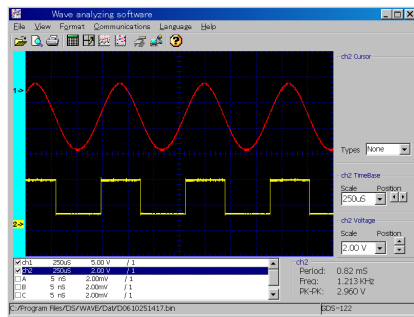

Connecting the GDS-122 to the software is completed

Configuring the screen

Overview

This section introduces how to configure the following parameters in the software screen (waveform viewing mode) to optimize the user interface.

- Background color
- Grid color
- Grid on/off
- Drawing format
- Language
- Closing the software

Screen overview

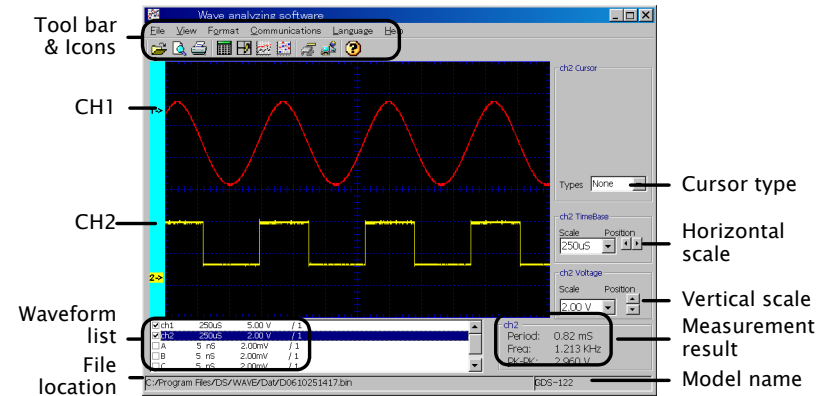

Changing the background color

To change the background color, select **View > Background Color** from the menu and select the new color from the color palette that appears. Alternatively, you can also double click inside the screen to call the color palette.

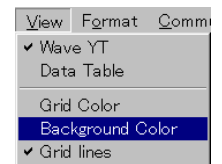

Black background

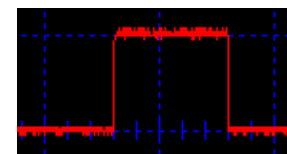

White background

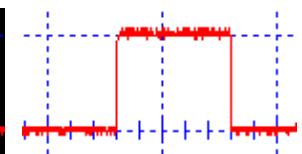

Turning the grid on or off

To turn on or off the grid, select View > Grid lines from the menu or click the Gridlines icon.

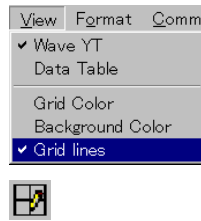

Grid on

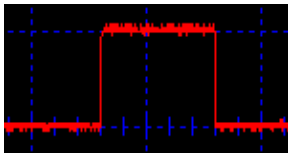

Grid off

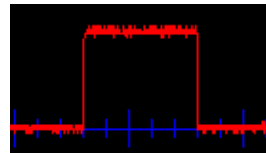

Changing the grid color

Make sure the grid is already turned on. Select View > Grid Color from the menu and select the new color from the color palette that appears.

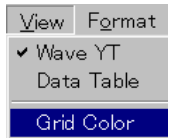

Blue grid

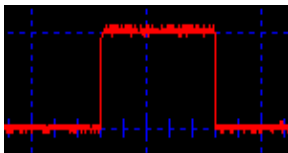

White grid

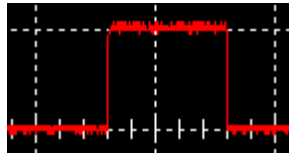

Changing the waveform drawing format

You can select how the waveform is being drawn from two formats, line and dots. Select Format > Data Line (Point) from the menu or click the icons.

Line

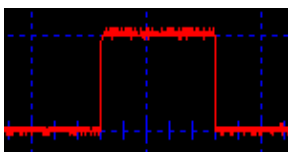
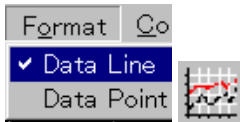

Point

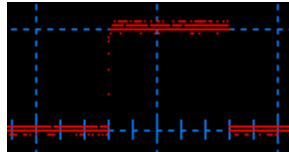
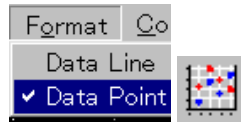

Changing the language

You can select the language from English (default) or Simplified Chinese. Select Language > English (Chinese) from the menu. The Language menu itself always stays as English.



Closing the software

You can close the software in one of the following ways. The screen configurations will be retained the next time you open the software.

- Pressing the Alt + F4 keys
- Selecting File > Exit from the menu

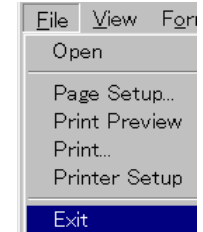

- Clicking the Close icon at the top right corner of the software



Viewing the waveforms

- Overview** This section introduces how to modify the waveform settings for better viewings.
- Selecting the displayed waveforms
 - Refreshing the waveforms
 - Selecting the active waveform
 - Changing the waveform positions
 - Changing the waveform scales
 - Viewing the automatic measurement results

Screen overview

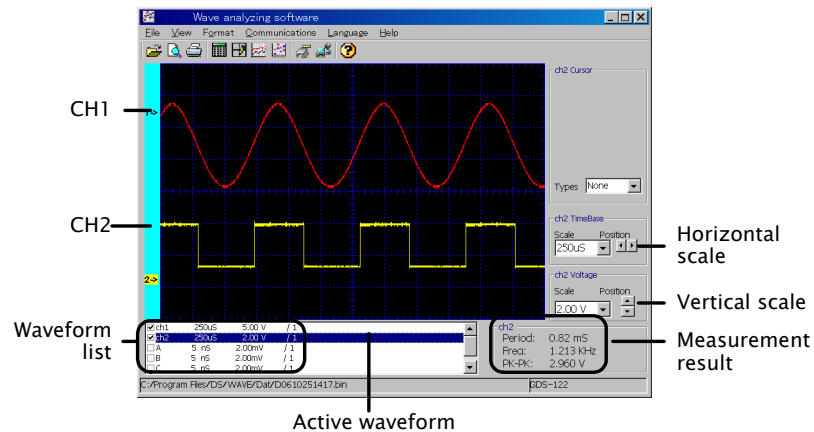

Selecting the displayed waveforms In the left bottom corner of the screen, put a checkmark in the waveform that needs to appear. Maximum six waveforms are available: CH1, CH2, A, B, C, D. Waveforms A to D have to be stored in the GDS-122 hardware beforehand (see page 54 for details).

(CH1, CH2 selected)

<input checked="" type="checkbox"/>	ch1	250uS	5.00 V	/ 1
<input checked="" type="checkbox"/>	ch2	250uS	2.00 V	/ 1
<input type="checkbox"/>	A	5 nS	2.00mV	/ 1
<input type="checkbox"/>	B	5 nS	2.00mV	/ 1
<input type="checkbox"/>	C	5 nS	2.00mV	/ 1

Refreshing the waveforms In the software, select **Communications – Get Data** from the menu. Alternatively, you may click the Get data icon, or press the shortcut keys, Ctrl + A.



Selecting the active waveform Waveform scale settings and automatic measurements are done on the active waveform.

1. Click on the waveform name in the bottom left corner of the screen.

(CH1 selected as the active waveform)

<input checked="" type="checkbox"/>	ch1	250uS	5.00 V	/ 1
<input checked="" type="checkbox"/>	ch2	250uS	2.00 V	/ 1
<input type="checkbox"/>	A	5 nS	2.00mV	/ 1
<input type="checkbox"/>	B	5 nS	2.00mV	/ 1
<input type="checkbox"/>	C	5 nS	2.00mV	/ 1

2. The following locations changes into the selected channel (example: CH1).

- Colored channel label (at the left side of the screen)
- Cursor, Time base, Voltage settings (at the right side of the screen)
- Automatic measurement results (at the bottom right corner of the display)

Changing the waveform positions

Changing the horizontal position

1. Move the mouse over the waveform until the mouse icon changes into a left-right arrow.

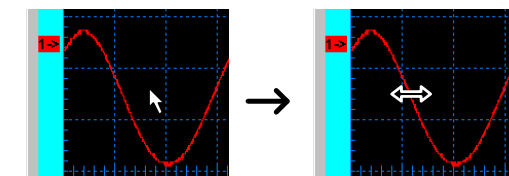

- Hold the mouse and drag the waveform sideways.

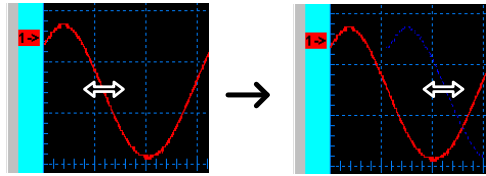

Changing the vertical position

Click the channel label at the left side of the waveform and drag the waveform up or down.

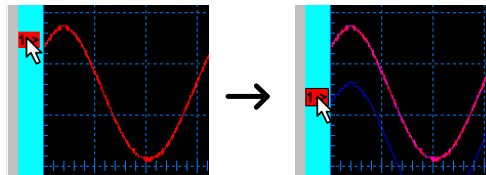

Changing the waveform scales

Before changing the scales, make sure that the correct waveform is selected (highlighted) in the lower left corner of the screen (example: CH1).



Changing the horizontal scale

Select the horizontal scale using the list at the right side of the screen. You can select the scale either by searching in the Scale column or by clicking the Position arrows.

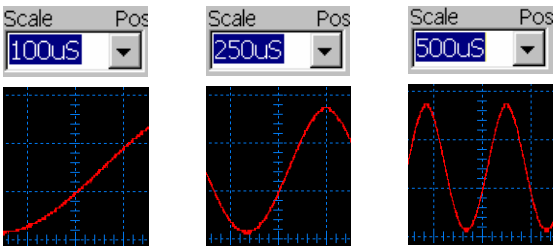
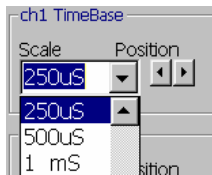

Changing the vertical scale

Select the vertical scale using the list at the right side of the screen. You can select the scale either by searching in the Scale column or by clicking the Position arrows.

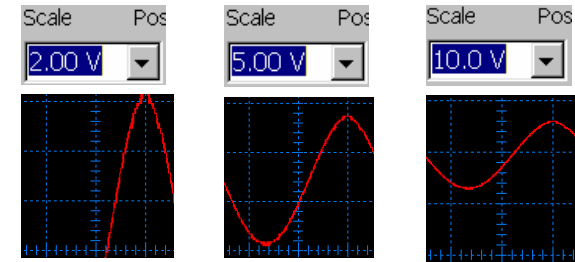
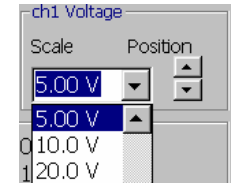

Viewing the automatic measurement results

Before viewing the measurement results, make sure that the correct waveform is selected (highlighted) in the lower left corner of the screen (example: CH1).

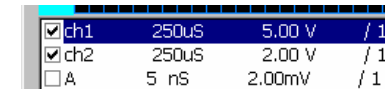

The measurement result is updated in the lower right corner of the screen. Three parameters are listed.

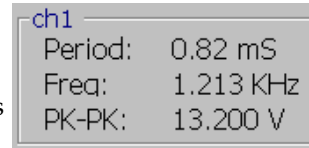

- Period: measures the waveform period in ms.
- Freq: measures the waveform frequency in kHz.
- PK-PK: measures the peak to peak voltage in V.

Using the cursor measurements

Overview This section introduces how to use cursor measurements in the software screen.

- Activating the cursors
- Viewing the cursor measurement results
- Moving the cursors

Screen overview

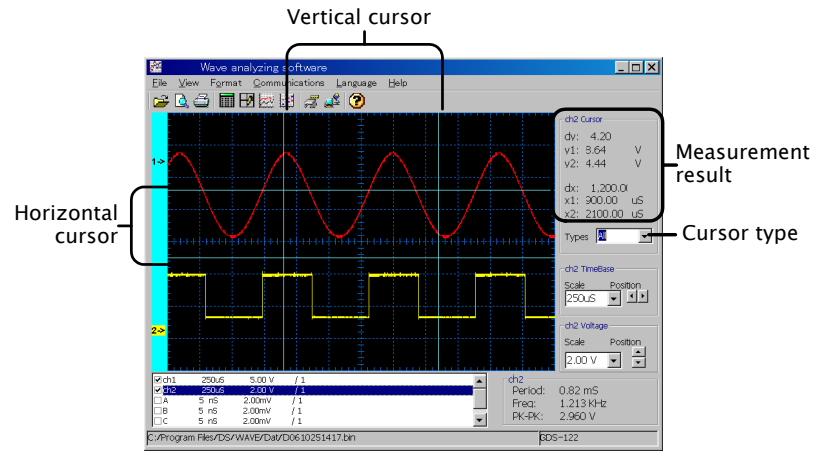

Activating the cursors

Before activating the cursors, make sure that the correct waveform is selected (highlighted) in the lower left corner of the screen (example: CH1).

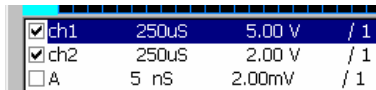

Select the cursors from the list in the right side of the screen.

- None: the cursor is turned off. Types
- Horizontal: the horizontal cursors appear. Types
- Vertical: the vertical cursors appear. Types

- All: both the horizontal and vertical cursors appear. Types

Viewing the cursor measurement results

The cursor measurement results are updated in the right side of the screen.

- dy: the voltage difference between y1 and y2 cursors
- y1, y2: voltage cursors 1 and 2
- dx: the time difference between x1 and x2 cursors
- x1, x2: time cursors 1 and 2

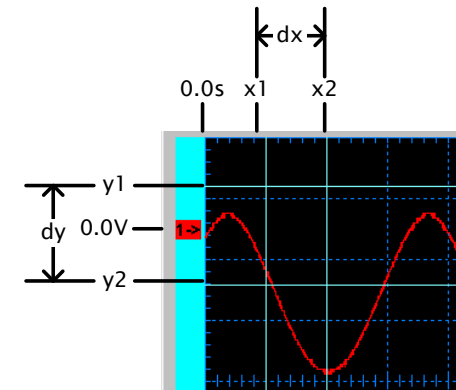
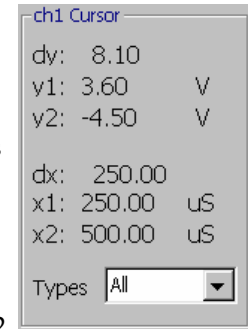

Moving the cursors

Move the mouse over the cursor until the mouse icon changes into a left-right arrow. Hold the mouse and drag the cursor sideways (horizontal cursor) or vertically (vertical cursor).

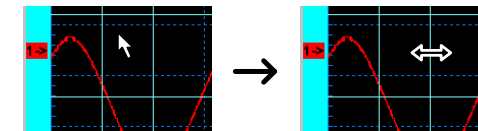

The cursor measurement result changes accordingly.

Saving waveforms

Overview

You can save the waveforms into the PC in two ways. For details of recalling them, see page79.

- Storing waveform data (*.bin file, for viewing in the software)
- Storing data points (*.txt file, for data analysis such as in graphs and maps)

For details of storing waveforms into the GDS-122 hardware, see page54.

Storing waveform data

When retrieving waveform data from the GDS-122, the waveform data (*.bin format) is automatically stored. For details, see page69.

Storing data point

1. Make sure that the waveform is being displayed in the screen. To recall waveforms that are stored in the PC, see page79.

2. Select **View > Data Table** from the menu, or click the Data Table icon on the Toolbar. The Data Table dialogue appears.

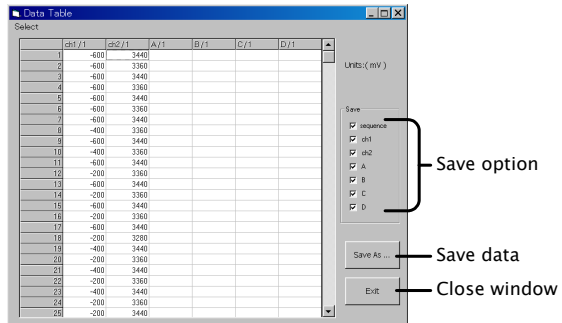
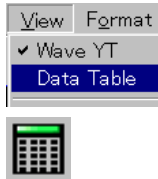

3. Select the data to be saved from the Save column.

- sequence: the identification number for each data point
- ch1/ch2: CH1 and CH2 waveform data
- A/B/C/D: the waveforms stored in the GDS-122 hardware memory

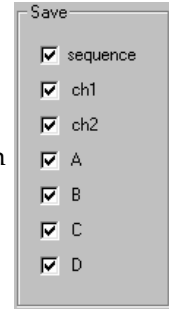

Data points stored in an Excel sheet (example)

sequence	ch1 / ch2	A / B / C / D				
A	B	C	D	E	F	G
1	Units: (mV)					
2	ch1 / 1	ch2 / 1	A / 1	B / 1	C / 1	D / 1
3	1	-600	3440			
4	2	-600	3360			
5	3	-600	3440			
6	4	-600	3360			

4. Click the Save As... button to save the data into a directory. The standard Save dialog appears.



5. To close the Data Point dialogue, do one of the following actions.

- Press the Ctrl + Alt key
- Click the Exit icon

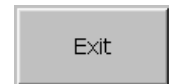

- Click the Close icon at the top right corner of the dialogue



Recalling waveforms

Overview You can recall the waveforms from the PC in two ways. For details of saving them, see page77.

- Recalling waveform data (*.bin file, for viewing in the software)
- Recalling data points (*.txt file, for data analysis such as in graphs and maps)

For details of recalling waveforms into the GDS-122 hardware, see page55.

Recalling the waveform data

1. Select **File > Open** from the menu or press the shortcut key, **Ctrl + O**.
2. The File Open dialogue opens. Select one of the SPB bin file (*.bin) and click OK.
3. The waveform(s) will be recalled in the screen.

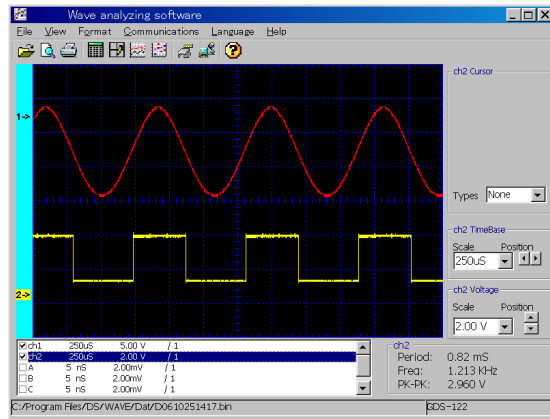

Recalling the data points

1. For recalling the data points, you need to open a text editor or a spreadsheet program like Excel, in which you can organize the data and create graphs and maps for advanced analysis.
2. Open the saved *.txt file from the application.

Printing out waveforms

Overview You can print out the screen contents to a printer connected to the PC. When you are printing the waveform for the first time, follow all the steps in the following order.

1. Setting up the printer
2. Setting up the page format
3. Printing out

Setting up the printer

1. Select **File > Printer Setup** from the menu. The standard printer setting dialogue opens.

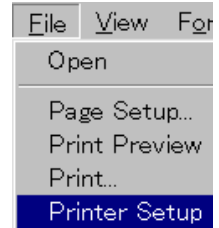

2. Select the printer and its properties, paper size, and orientation.

Setting up the page format

1. Select **File > Page Setup** from the menu. The Page Setup dialog window opens.

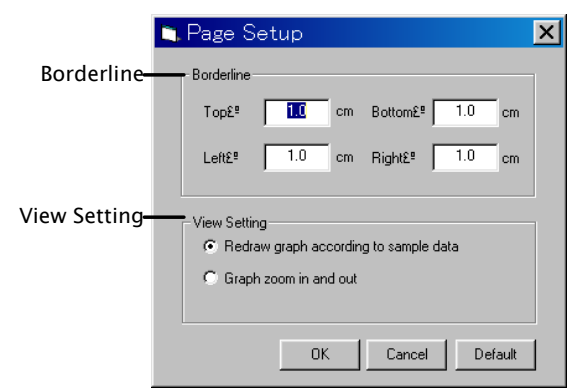
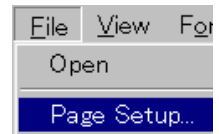

2. Set the borderlines (print margins). The range is 0 to 10.0cm each.

3. Select the View Setting.

Redraw graph according to sample data:

The GDS-122 refreshes the waveform and adjust its scale before printing. The most recent data can be taken, but might take time for refreshing.

Graph zoom in and out

The existing waveform is used with its scale adjusted. Since retrieving the data is not involved, fast printing is ensured.

4. Open the print preview by selecting File > Print Preview from the menu or clicking the Print Preview icon on the toolbar. Make sure that the waveforms are placed appropriately.

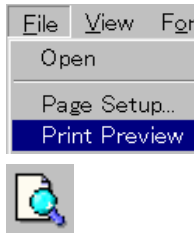

Printing out Print out the waveform in one of the following ways.

• Selecting File > Print in the Print Preview screen menu



• Selecting File > Print from the software menu

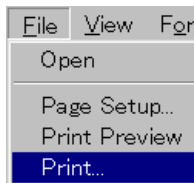

• Pressing the shortcut keys, Ctrl + P

• Clicking the Printer icon on the Toolbar



Accessing the Help

Overview The Help file describes how to install and use the software. The About screen shows the software version.

Opening the Help Open the Help in separate file using one of the following methods.

- Selecting Help > Help from the menu
- Clicking the Help icon on the Toolbar
- Pressing the shortcut key, F1
- Selecting the Help documentation from the startup menu

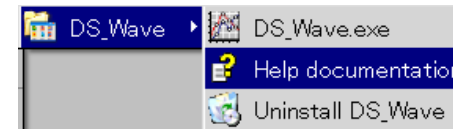

Software version To view the software version, select Help > About from the menu. The software version screen appears.

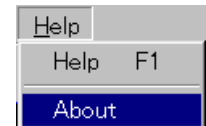













USING THE MULTIMETER

This chapter describes the multimeter functionalities in the GDS-122. Functionalities includes three major items (Voltage, Current, Impedance) and three additional items (Diode, Continuity, Capacitance). The current measurement and capacitance measurement use extension modules to deal with large current and small capacitance, respectively. Delta measurement and automatic range switching features offer flexibility and convenience.

Activating the Multimeter	84
Measuring Voltage	85
Measuring Current	87
Measuring Impedance	89
Measuring Diode	91
Measuring Continuity	92
Measuring Capacitance	93

Activating the Multimeter

- Panel operations
1. Press the power switch. The welcome screen with the corporate logo appears on the display. 
 2. To adjust display brightness, use the switch on the side: up (bright) or down (dark). 
 3. Press any key (example: MENU (Example) key) to activate the display. The battery icon at the top left corner of the display shows the battery level. 

> 75%	75%	50%	25%	< 25%
				
- If the oscilloscope screen appears, press the DMM/OSC key and change the mode to multimeter. 
4. Press A (current), V (voltage), or R (impedance, diode, continuity, capacitance) switch to proceed. A warning message might appear to remind you of correct connections. 





5. Press any key to cancel the warning message and resume the measurement.

Measuring Voltage

DC voltage specifications (details: page98)	Range	400mV, 4V, 400V
	Accuracy	±(1% + 1 digit)
	Max input	400V

AC voltage specifications (details: page98)	Range	4V, 40V, 400V
	Accuracy	±(1% + 3 digits)
	Max input	400V
	Frequency	40Hz to 400Hz

Panel operations 1. Press the V switch to select the Voltage measurement. If a warning message appears, press any key to resume measurement.



2. The voltage measurement screen appears.

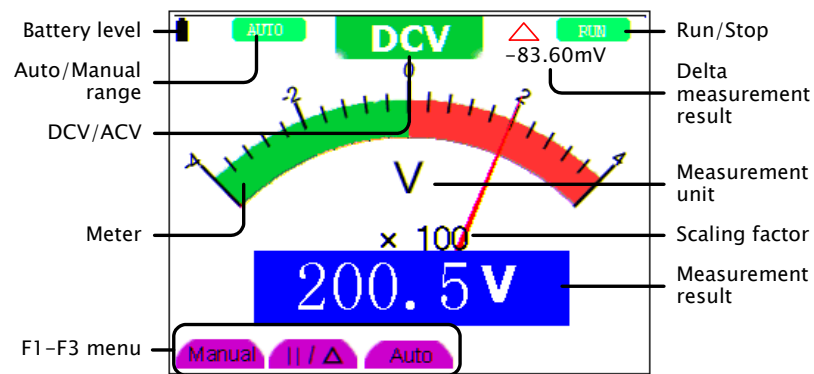

3. Press the AUTOSET key repeatedly to select DC or AC voltage measurement.



4. Connect the test leads to the terminals:
COM for the black lead
V/Ω/C for the red lead

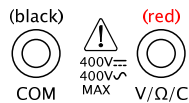

5. The measurement result will be constantly updated in the display. For more detailed settings, see the following instructions.

Auto ranging To let the GDS-122 select the voltage range automatically, press F3 (Auto). The indicator at the top left corner of the display changes to AUTO.



Manual ranging To select the voltage range manually, press F1 (Manual). The indicator at the top left corner of the display changes to MANUAL.



Freezing the measurement To freeze the measurement, press the RUN/STOP key. The measurement result will be retained and the indicator at the top right corner of the display changes to STOP. To unfreeze, press the RUN/STOP key again.



Measuring delta voltage To measure the delta value, press F2 (II/Δ). The measurement result at the moment moves to the top right corner of the display, and the measurement result becomes the difference between the original result.

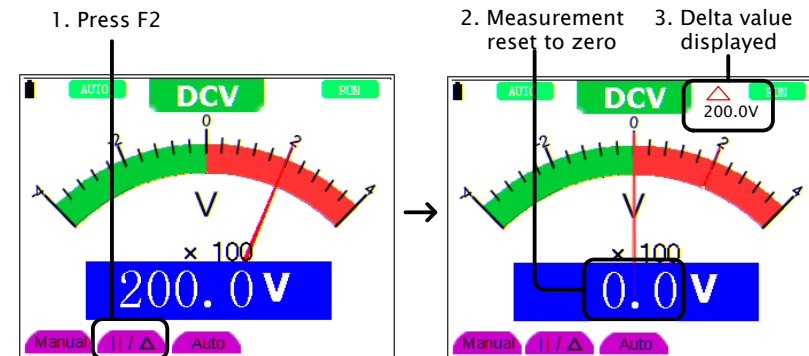

Measuring Current

DC current specifications (details: page98)	Range & Accuracy	40mA ±(1% + 1 digit) 400mA ±(1.5% + 1 digit) 20A ±(3% + 3 digits)
	Max input	400mA (direct input) 20A (via the extension module)
AC current specifications (details: page98)	Range & Accuracy	40mA ±(1.5% + 3 digits) 400mA ±(2% + 1 digit) 20A ±(5% + 3 digits)
	Max input	400mA (direct input) 20A (via the extension module)

Panel operations 1. Press the A switch to select the current (Ampere) measurement. If a warning message appears, press any key to resume measurement.

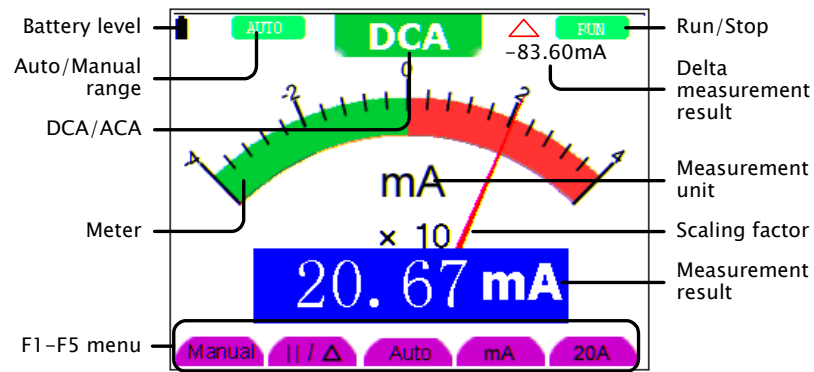

2. Press the AUTOSET key repeatedly to select DC or AC current measurement.

Measuring 0mA to 400mA 1. Connect the test leads to the terminals: COM for the black lead mA/A for the red lead

If the range is set at 20A, press F4 (mA) and change it to mA range.

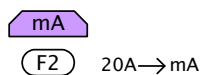
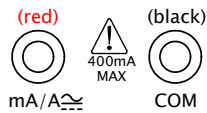

2. Select automatic range by pressing F3 (Auto) or manual by F1 (Manual). The indicator at the top left corner of the display changes accordingly.

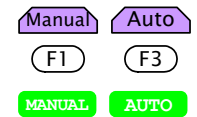

Measuring 400mA to 20A ⚠

1. Connect the Current Extension module to the COM & mA/A terminals. Then, connect the test leads to the extension module.

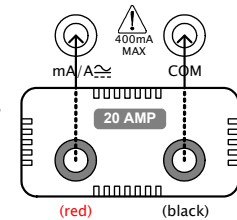

2. Press F5 (20A) and select the 20A range. The MANUAL range indicator activates. (Auto range is not available)

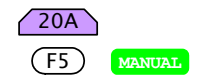

Freezing the measurement

To freeze the measurement, press the RUN/STOP key. The measurement result will be retained and the indicator at the top right corner of the display changes to STOP. To unfreeze, press the RUN/STOP key again.

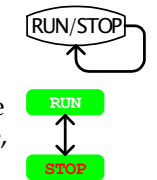

Measuring delta current

To measure the delta value, press F2 (II/Δ). The measurement result at the moment moves to the top right corner of the display, and the measurement result becomes the difference between the original result.

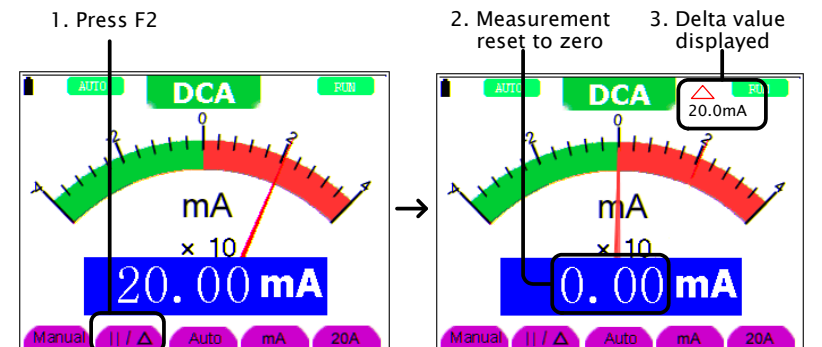
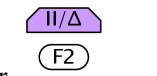



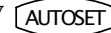

Measuring Impedance

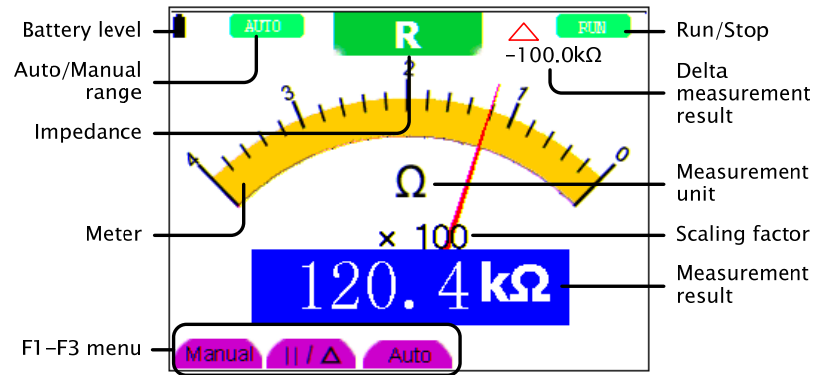

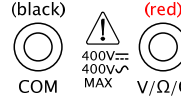
Impedance specifications (details: page98)	Range & Resolution	400Ω ±(1% + 3 digits)
		4k, 40k, 400k, 4MΩ ±(1% + 1 digit)
		40MΩ ±(1.5% + 3 digits)



- Panel operations
1. Press the R switch. If a warning message appears, press any key to resume measurement. 
 2. Press the AUTOSET key repeatedly to select the impedance measurement. 
 3. The impedance screen appears.





4. Connect the test leads to the terminals:
COM for the black lead
V/Ω/C for the red lead 
5. The measurement result will be constantly updated in the display. For more detailed settings, see the following instructions.

Auto ranging To let the GDS-122 select the voltage range automatically, press F3 (Auto). The indicator at the top left corner of the display changes to AUTO. 



Manual ranging To select the voltage range manually, press F1 (Manual). The indicator at the top left corner of the display changes to MANUAL. 



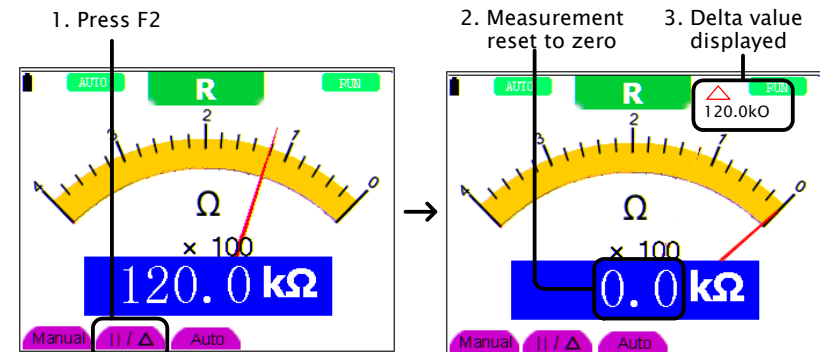

Freezing the measurement To freeze the measurement, press the RUN/STOP key. The measurement result will be retained and the indicator at the top right corner of the display changes to STOP. To unfreeze, press the RUN/STOP key again. 



Measuring delta impedance To measure the delta value, press F2 (II/Δ). The measurement result at the moment moves to the top right corner of the display, and the measurement result becomes the difference between the original result. 





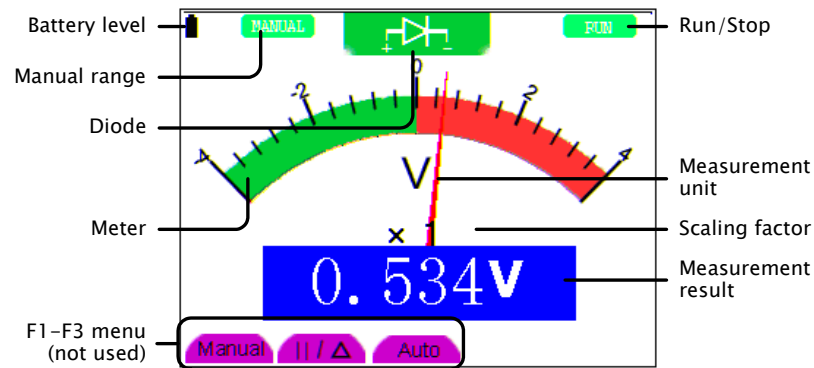

Measuring Diode

Range 0V to 1.5V

- Panel operations
1. Press the R switch. If a warning message appears, press any key to resume measurement.  
 2. Press the AUTOSET key repeatedly to select the diode measurement. 
 3. The diode measurement screen appears.



4. Connect the test leads to the terminals:
COM for the black lead    for the red lead
5. The measurement result will be constantly updated in the display.



Freezing the measurement

To freeze the measurement, press the RUN/STOP key. The measurement result will be retained and the indicator at the top right corner of the display changes to STOP. To unfreeze, press the RUN/STOP key again.





Measuring Continuity

Conditions < 50Ω (beeping)

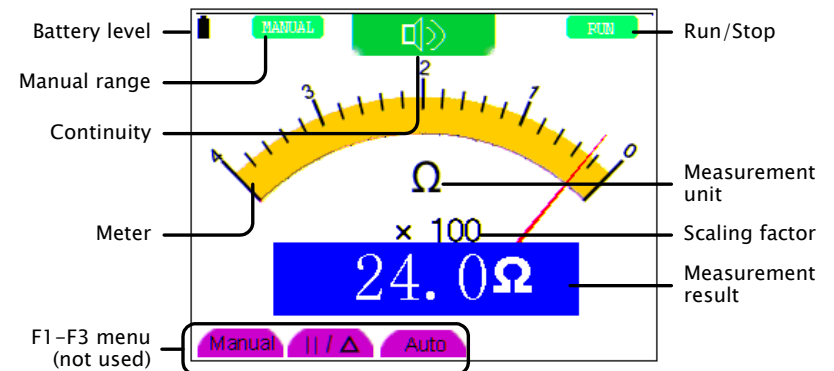
- Panel operations
1. Press the R switch. If a warning message appears, press any key to resume measurement.  
 2. Press the AUTOSET key repeatedly to select the continuity measurement. 
 3. The continuity measurement screen appears.



4. Connect the test leads to the terminals:
COM for the black lead    for the red lead
5. If the GDS-122 confirms continuity (the impedance is less than 50Ω), the beeper sounds.

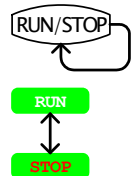

Freezing the measurement

To freeze the measurement, press the RUN/STOP key. The measurement result will be retained and the indicator at the top right corner of the display changes to STOP. To unfreeze, press the RUN/STOP key again.





Measuring Capacitance

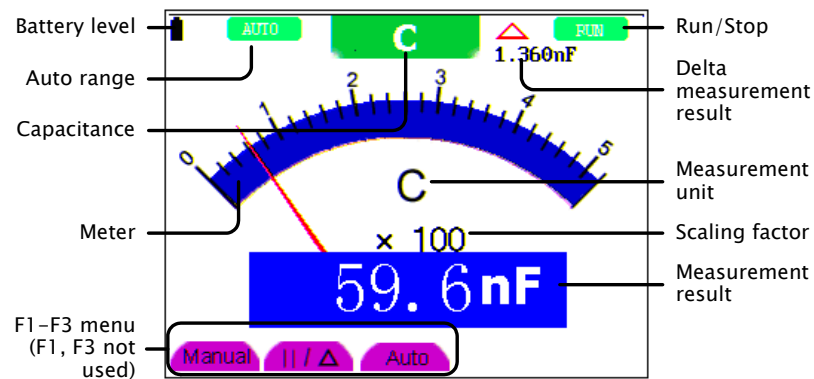

Continuity specifications Range 51.2nF to 100uF ±(3% + 3 digits)

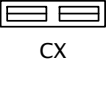

- Panel operations
1. Press the R switch. If a warning message appears, press any key to resume measurement. 
 2. Press the AUTOSET key repeatedly to select the capacitance measurement. 
 3. The capacitance screen appears.

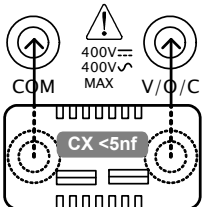

Measuring 5nF and above Connect the test leads to the CX terminals. 

Measuring less than 5nF  Connect the Capacitance Extension module to the COM & V/Ω/C terminals. Then, connect the test leads to the extension module. The measurement result will be constantly updated in the display. 

Freezing the measurement To freeze the measurement, press the RUN/STOP key. The measurement result will be retained and the indicator at the top right corner of the display changes to STOP. To unfreeze, press the RUN/STOP key again. 

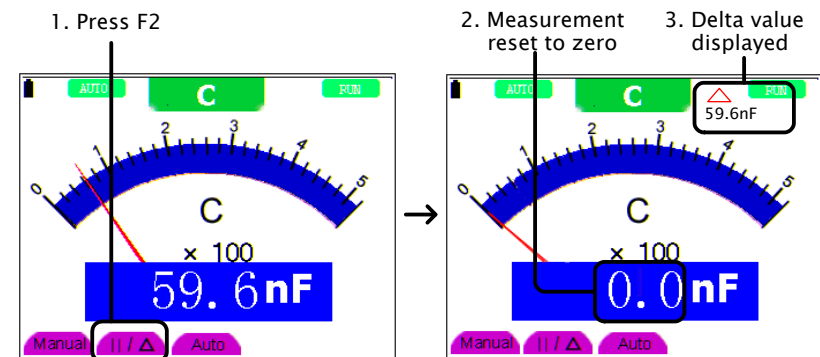

Measuring delta capacitance To measure the delta value, press F2 (II/Δ). The measurement result at the moment moves to the top right corner of the display, and the measurement result becomes the difference between the original result. 



FAQ

Power	<p>Q</p> <ul style="list-style-type: none"> • The GDS-122 does not power up. • The GDS-122 stopped working after a short period of time. <p>A</p> <p>The battery may need recharging. Connect the GDS-122 to the AC adaptor and recharge it for at least 15 minutes. Then try powering up.</p>
ERR mode in the multimeter	<p>Q</p> <p>In the multimeter mode, the measurement type at the top of the display says "ERR" which looks like an error message.</p> <p>A</p> <p>The "ERR" sign appears when none of the measurement switch is pressed. Select one from the V, A, or R switch and press it.</p>
Amplitude mismatch in the oscilloscope	<p>Q</p> <p>The measured voltage is 10 times smaller than the real value.</p> <p>A</p> <p>The attenuation ratio on the probe is set at x10. If you switch it to x1, make sure that the input voltage does not surpass the maximum 400V.</p> <p>Q</p> <p>The measured voltage is 10/100/1000 times larger than the real value.</p> <p>A</p> <p>The probe ratio in the CH1 or CH2 setup menu is set at X10, X100, or X1000. See page21 for details.</p>
Unstable waveform in the oscilloscope	<p>Q</p> <p>The waveform appears in the display but is not stable.</p> <p>A</p> <p>Configuring the trigger might help you. See page29 for details.</p> <ul style="list-style-type: none"> • Make sure the trigger source channel matches the input signal. • Make sure the correct trigger type, edge or

	<p>video, is selected.</p> <ul style="list-style-type: none"> • Try changing the HF and LF repression in the trigger coupling mode and filtering out high or low frequency noise.
No waveform in the oscilloscope	<p>Q</p> <p>The waveform does not appear at all in the display.</p> <p>A</p> <ul style="list-style-type: none"> • The trigger level might be out of the waveform range. Press the AUTOSET key so that the GDS-122 automatically adjusts the trigger level. • If the trigger mode is Single, press the RUN/STOP key to trigger the waveform or switch the trigger mode to Normal. See page29 for trigger details.
Slow update in the multimeter	<p>Q</p> <p>It takes 30 to 40 seconds for the multimeter to update the capacitor measurement.</p> <p>A</p> <p>It takes longer time to measure small capacitors. 30 to 40 seconds are normal for measuring 5nF or smaller capacitors. See page93 for capacitance measurement details.</p>
Slow update in the oscilloscope	<p>Q</p> <p>The display response to the waveform change is unusually slow.</p> <p>A</p> <p>Slow response is normal in the following cases.</p> <ul style="list-style-type: none"> • Average sampling mode is being selected (page21) • Display persistence is being selected (page36)
Language	<p>Q</p> <p>I want to switch the language from Chinese to English (or vice versa).</p> <p>A</p> <p>Press the menu key and select "FUNCTION" or "功能设置" using the IJp/Down keys, then press F3 (Language/语言). See page35 for details.</p>

SPECIFICATIONS

Conditions for specifications The following specifications are applicable when these two conditions are met:

- The GDS-122 has been powered up for at least 30 minutes, during which temperature fluctuation is no more than 5 degrees Celsius.
- The probe attenuation is set to X 10.

Oscilloscope specifications

Sampling	Mode	Normal, Peak detection, Average
	Rate	100 MSa/s
Input	Coupling	DC, AC
	Impedance	1M Ω ±2% in parallel with 20pF±3pF
	Probe	1X, 10X, 100X, 1000X
	Max. Input	400V (peak)
	Channel delay	150ps (typical)
Horizontal	Sampling rate	10S/s~100mS/s
	Interpolation	(sin x) /x
	Record length	6K points on each channel
	Scanning speed	5ns/div~5s/div, 1-2.5-5 step
	Sampling rate / relay time accuracy	±100ppm (time interval ≥ 1ms)
	Interval (ΔT) accuracy (full bandwidth)	Single: ±(1 interval time +100ppm×reading+0.6ns) Average >16 : ±(1 interval time +100ppm×reading+0.4ns)
	A/D converter	8 bits resolution (2CH simultaneously)
Vertical	Sensitivity	5mV/div~5V/div (at input)
	Displacement	±50V(500mV~5V), ±1V(5mV~200mV)
	Bandwidth	20M
	Single	Full bandwidth
	Low frequency	≥5Hz (at input, AD coupling, -3dB)
	Rise time	≤17.5ns (at input, typical)
	DC accuracy	±5% (DC gain)
	DC accuracy (avg)	Avg >16: ±(5% rdg + 0.05 div) for ΔV

Trigger	Sensitivity	CH1 and CH2: 1div(DC~full bandwidth) DC coupling: ≥ 50Hz.	
	Trigger level	±6 divisions from the screen center	
	Level accuracy	±0.3 div (typical, rise/fall time ≥ 20ns)	
	Displacement	655div (pre-trigger), 4div (post-trigger)	
	50% level setting	Input signal frequency ≥ 50Hz (typical)	
	Trigger sensitivity	2 div of peak-to-peak (video trigger)	
	Signal system	NTSC, PAL, SECAM (any frequency)	
Measurement	Cursor	ΔV and ΔT between cursors	
	Automatic	Peak-to-peak, average, root mean square, frequency, and cycle.	
Probe		1X position	10X position
	Bandwidth	≤ 6 MHz (DC)	Full bandwidth (DC)
	Attenuation rate	1: 1	10: 1
	Compensation	10pf~35pf	10pf~35pf
	Input impedance	1M Ω ±2%	10M Ω ±2%
	Input impedance	85pf~115pf	14.5pf~17.5pf
	Input voltage	150 V DC	300V DC

Multimeter specifications

VDC	Input impedance	10M Ω	
	Max input	1000V (DC or AC peak-to-peak value)	
	Accuracy	±1%±1 digit	
	Resolution	400mV range: 100uV	
		4V range: 1mV 40V range: 10mV 400V range: 100mV	
VAC	Input impedance	10M Ω	
	Max input	750V(AC, virtual value)	
	Frequency range	40Hz~400Hz	
	Display	Virtual value of sine wave	
	Accuracy	±1%±3 digits	
	Resolution	4V range: 1mV 40V range: 10mV 400V range: 100mV	
DCA		Accuracy	40mA range: ±1%±1 digit 400mA range: ±1.5%±1 digit 20A range: ±3%±3 digits
		Resolution	40mA range: 10uA

		400mA range: 100uA 20A range: 10mA
ACA	Accuracy	40mA range: $\pm 1.5\% \pm 3$ digit 400mA range: $\pm 2\% \pm 1$ digit 20A range: $\pm 5\% \pm 3$ digits
	Resolution	40mA range: 10uA 400mA range: 100uA 20A range: 10mA
Resistance	Accuracy	400Ω range: $\pm 1\% \pm 3$ digits 4kΩ~4MΩ range: $\pm 1\% \pm 1$ digit 40MΩ range: $\pm 1.5\% \pm 1$ digit
	Resolution	400Ω range: 0.1Ω 4kΩ range: 1Ω 40kΩ range: 10Ω 400kΩ range: 100Ω 4MΩ range: 1kΩ 40MΩ range: 10kΩ
Capacitance	Accuracy	$\pm 3\% \pm 3$ digits
	Resolution	51.2nF range: 10pF 512nF range: 100pF 5.12uF range: 1nF 51.2uF range: 10nF 100uF range: 100nF
Diode	Reading range	0V~1.5V
Continuity	Threshold	< 30Ω

General specifications

Display	Type	3.8" color liquid crystal display
	Resolution	320 (horizontal) × 240 (vertical) pixels
	Color	4096 colors
Power	Consumption	< 6W
	Supply	100V~240V AC, 50/60Hz
	DC input	8.5VDC, 1500mA
Environment	Operating	Temperature: 0 to 40 °C(32 to 104 °F) Relative humidity: < 75%
	Storage	Temperature: -20 to 60 °C(-4 to 140 °F) Relative humidity: < 75%
Mechanical	Dimension	18 cm×11.5cm×4cm
	Weight	645g

DECLARATION OF CONFORMITY

We

GOOD WILL INSTRUMENT CO., LTD.

(1) No.7-1, Jhongsing Rd., Tucheng City, Taipei County, Taiwan

(2) No. 69, Lu San Road, Suzhou City (Xin Qu), Jiangsu Sheng, China

declare, that the below mentioned product

Type of Product: Handheld Digital Storage Oscilloscope & Multimeter

Model Number: GDS-122

is herewith confirmed to comply with the requirements set out in the Council Directive on the Approximation of the Law of Member States relating to Electromagnetic Compatibility (89/336/EEC) and Low Voltage Directive (73/23/EEC).

For the evaluation regarding the Electromagnetic Compatibility and Low Voltage Directive, the following standards were applied:

© **EMC**

EN 61326-1: Electrical equipment for measurement, control and laboratory use — EMC requirements (1997 + A1:1998 + A2:2001 + A3:2003)	
Current Harmonics	Voltage Fluctuations
EN 61000-3-2: 2000 + A2:2005	EN 61000-3-3: 1995 + A1:2001
-----	-----
-----	-----

© **Safety**

Low Voltage Equipment Directive 73/23/EEC
Safety Requirements
IEC/EN 61010-1: 2001 (2nd Edition)

INDEX

AC coupling	
trigger	31
vertical	23
ACA multimeter	87
specifications	99
AC-DC adaptor	10
acquisition	34
short cuts	58
system status	37
ACV multimeter	85
specifications	98
addition, math mode	39
auto ranging	
impedance multimeter	89
voltage multimeter	86
auto trigger mode	30
AUTO trigger status	26
automatic measurements	41
shortcuts	57
Autoset	18
capacity multimeter	93
continuity, multimeter	92
diode, multimeter	91
impedance measurement	89
voltage multimeter	85
average acquisition mode	34
application	49
background color, PC software	68
battery level	16
calibration	51
short cuts	58
capacitance measurement,	
multimeter	93
specifications	99
carry, interface setting	66
carrying case	10
caution symbol	6
CD-ROM	10
channel	
edge trigger	30
on/off	22
video trigger source	33
Chinese, language selection	35
contents of package	10
continuity, multimeter	92
specifications	99
coupling	
system status	38
trigger	31
vertical	23
cursor measurement	
PC software	75
short cuts	57
time	42
voltage	43
cycle rms, automatic measurement	41
data point, storing	77
data table, PC software	77
DC coupling	
trigger	31
vertical	23
DCA multimeter	87
specifications	98
DCV multimeter	85
specifications	98
default settings	53
delta measurement	
capacitance multimeter	94
current multimeter	88
impedance multimeter	90
voltage multimeter	86
diode measurement, multimeter	91
specifications	99
display	
acquiring snapshot	67
brightness adjustment	16

overview	19
settings	36
shortcuts	59
specifications	99
division, math mode	39
dot drawing	36
edge trigger	29
auto mode	30
coupling mode	31
mode	30
normal mode	31
single mode	31
EN61000	100
EN61010	
declaration of conformity	100
measurement category	7
pollution degree	7
EN61326-1	100
English, language selection	35
environment	
operation	7
specifications	99
storage	8
ERR mode, multimeter	95
extension module	
capacitance multimeter	93
current multimeter	88
package	10
factory settings	53
FAQ	95
ERR mode, multimeter	95
magnification	95
no waveform	96
powering up	95
slow update, multimeter	96
slow update, oscilloscope	96
unstable waveform	95
field trigger, video	33
freezing measurement	
capacitance multimeter	94
continuity multimeter	92
current multimeter	88
diode multimeter	91
impedance multimeter	90
voltage multimeter	86
frequency, automatic measurement	41
front panel overview	12
grid color, PC software	69
grid, PC software	69
ground symbol	6
help, PC software	82
Hf Rjc	31
horizontal	
adjusting position	20, 24
adjusting scale	19, 25
scale vs trigger status	27
short cuts	58
specifications	97
system status	37
impedance, multimeter	89
specifications	99
installing PC software	62
inverting channel	23
language	35
PC software	70
short cuts	58
LF Rjc	31
line data, PC software	69
line trigger, video	33
list of features	11
magnification, vertical	24
manual ranging	
current multimeter	88
impedance multimeter	90
voltage multimeter	86
manual, overview of	14
math mode	39
shortcuts	57
system status	38
mean voltage, auto measurement	41
multimeter	
activating	84
capacitance measurement	93
continuity measurement	92
current measurement	87
diode measurement	91
ERR mode	95
impedance measurement	89
specifications	98
switching to oscilloscope	84
voltage measurement	85
warning message	84

multiplication, math mode	39	probe	
noisy signal, viewing	49	adjusting display magnification	17
normal trigger mode	31	adjustment tool	10
operation environment	7	calibration	52
OSC option key	60	package	10
oscilloscope		setting attenuation	17
specifications	97	specifications	98
switching to multimeter	16	Ready trigger status	26
package contents	10	recalling	
PC software		default settings	53
activation	65	default settings, shortcuts	58
cursor measurement	75	waveforms from GDS-122	55
help	82	waveforms, PC software	79
installation	62	resetting trigger level	28
overview	61	run trigger	27
package	10	sample acquisition mode	34
printing out	80	saving	
saving waveform	77	shortcuts	59
screen overview	68	waveforms in PC software	77
uninstall	64	waveforms inside GDS-122	54
version	82	scale	
viewing waveforms	71	horizontal	25
peak detect acquisition mode	34	math mode	40
application	48	vertical	22
period, automatic measurement	41	waveform, PC software	73
persistence setting	36	xy mode	47
application	50	zoom	46
pk-pk voltage, automatic		Scan trigger status	26
measurement	41	self calibration	51
point data, PC software	69	SET1/2, automatic measurement	41
position		signal peak, viewing	48
horizontal	24	single trigger mode	31
math mode	40	slope, trigger	29
shortcuts	60	snapshot, display	67
time cursor	43	software version	82
trigger	27	specifications	
vertical	22	general	99
voltage cursor	44	multimeter	98
waveform, PC software	72	oscilloscope	97
xy mode	47	stop trigger	27
power supply		STOP trigger status	26
safety instructions	7	storage environment	8
specifications	99	subtraction, math mode	39
power up, faq	95	synchronization, video trigger	33
powering up	16	system status	37
print out, PC software	80	shortcuts	59

test lead	10	USB driver installation	65
threshold, continuity multimeter	92	variations, viewing	50
tilt stand	17	vector drawing	36
time cursor	42	vertical	
Trig'd trigger status	26	adjusting position	20, 22
trigger		adjusting scale	19, 22
adjusting level	27	inverting channel	23
auto mode	30	selecting coupling mode	23
channel, edge trigger	30	selecting magnification	24
coupling mode	31	shortcuts	56
edge triggering	29	specifications	97
mode	30	system status	38
normal mode	31	video trigger	32
run/stop	27	field trigger	33
shortcuts	56	line trigger	33
single mode	31	source channel	33
slope	29	sync	33
source channel, video	33	voltage cursor	43
specifications	98	warning message, multimeter	84
status icons	26	warning symbol	6
status vs horizontal scale	27	xy mode	47
sync, video trigger	33	system status	37
system status	38	zoom waveform	45
video	32	system status	37
UK power cord	8		